

**EVIRON QUARRY AND LANDFILL PROJECT SITE  
HAUL ROAD CONSTRUCTION  
SOIL AND WATER MANAGEMENT PLAN**

**Version 1 September 2016**

THIS PAGE IS BLANK

Tweed Shire Council Environmental Scientist will maintain, review and update this plan as works progress or as need arises.

**Amendment**

Each new revision to the ESCP will be distributed to users with an instruction that the previous plan has been superseded.

The following provides a record of amendments made to this document:

Revision	Date	Description	Prepared	Reviewed
1	28/09/2016	Draft	G. Jones	D. Hannah, R. Hanby



# Table of Contents



<b>1</b>	<b>scope of works</b>	<b>1</b>
1.1	Introduction	1
<b>2</b>	<b>Site Background Information</b>	<b>2</b>
2.1	Site Description	2
2.2	Local Soils and Constraints	3
2.2.1	Soil landscape Mapping	3
2.2.1	Constraints	4
2.3	Imported Material	4
2.3.2	Characteristics of Imported Material	2
<b>3</b>	<b>Soil and water management Plan</b>	<b>6</b>
3.1	TSC Development Design Specification- Stormwater Quality	6
3.2	General Requirements	6
3.3	Schedule of Works	7
3.4	Sequence of site controls	8
<b>4</b>	<b>Erosion &amp; Sediment Control Measures</b>	<b>10</b>
4.1	Erosion Controls	10
4.2	Stabilisation Measures	10
4.3	Sediment Control	12
4.4	Sediment Basins	14
4.5	Water Management	16
4.6	Monitoring of Weather Conditions	17
<b>5.0</b>	<b>Inspection, Monitoring and auditing</b>	<b>19</b>
5.1	Site Inspection and Monitoring	19
5.2	Discharge Water Quality Objectives	21
5.3	Auditing and Record Keeping	22
5.4	Non Conformance	23
5.5	Reporting a Pollution Event	23
5.6	Review and Improvement of the SWMP	24
5.7	Responsibilities and Contacts	25
<b>6</b>	<b>References</b>	<b>26</b>
	<b>Appendices</b>	<b>27</b>
	APPENDIX A - TSC Erosion and Sediment Control Design Plans	27
	APPENDIX B – Code of Practice	29
	APPENDIX C - Standard Drawings and Examples	31
	APPENDIX D - Sediment Basin Designs	43

# Table of Contents



APPENDIX E - Sediment Basin Water Management .....	48
APPENDIX F - Vegetation Stabilisation.....	50
APPENDIX G - Monitoring and Auditing Templates.....	55



# 1 SCOPE OF WORKS

## 1.1 Introduction

This soil & water management plan (SWMP) has been developed to manage the importing of fill material to construct a new private haul road from the existing Tweed Shire Council (TSC) landfill at Stotts Creek Resource Recovery Centre (SCRRC) to a proposed new landfill site at Quirks Quarry. The new haul road would be constructed in two stages.

Stage I would be constructed and managed by TSC and would entail the construction of approximately 1km of haul road. The haul road would commence from the existing Quirks Quarry site and would continue approximately north for approximately 1km. Stage II would be constructed by contractors and would commence from where the TSC haul road terminates and continue to the SCRRC site. Management for stage II would be submitted by the successful contractor selected by a tender process. This management plan only addresses the works related Stage I to be undertaken by TSC.

The haul road would be constructed from approximately 25,000 cubic metres of suitable fill material and constructed as a flood free haul road elevated above the existing low lying land. For the purpose of heavy vehicle movements within the two landfill sites the design criteria for the haul road would include:

- A maximum road formation vertical grade of 10%.
- A maximum road formation horizontal bend radius of 75m.
- A total road formation width of 10m.
- A maximum batter grade of 1v:1.5h

For the purpose of this SWMP the term fill refers to suitable imported material as classified within the NSW Waste Classification Guidelines (2014) and NSW Resource Recovery Exemptions and Orders as issued by the NSW Environment Protection Authority (EPA). Prior to acceptance at the haul road project site, material would be classified to determine if it meets any of the following criteria and therefore be suitable for importing to haul road site:

- Virgin Excavated Natural Material or VENM
- Excavated Natural Material or ENM (refer to ENM exemption and order 2014)
- Excavated Public Road Material or EPRM (refer to TSC EPRM exemption and order 2016)

Material imported to the site characterised as TSC EPRM (2016) would be managed in-line with the Eviron Haul Road Excavated Road Material Management Plan (2016). Only material that meets the above listed criteria can legally be imported to the site, for the purpose of constructing the haul road. All material that is imported to site will be in receipt of a clearance certificate stating the classification of the material.

As a considerable amount of fill is required to complete the project it is proposed to import the material to site as it becomes available from TSC operations. This effectively means the construction of the haul road will be staged over time and would therefore require a

progressive management plan for the duration of the haul road construction project. It is anticipated that works would commence in the second half of 2016 and continue as material becomes available until works are completed. It is expected that the haul road may take some years to complete. In regards to the TSC ERM order and exemption (2016) it is noted that the NSW EPA exemption commences on 1 June 2016 and is valid to 30 May 2018.

For the purpose of this SWMP the **subject Site** is defined as Stage I of the haul road originating from Quirks Quarry and continuing for a distance of approximately 1km north towards the SCRRC site. Refer to Appendix A for design plans and Figure 1 for the location of the subject site.

Reference to the **Blue Book** refers to the industry common name for the publication Managing Urban Stormwater: Soils and Construction Volume 1, 4<sup>th</sup> Edition published in 2004 by Landcom which is considered as one of the main guiding documents for this SWMP.

## 2 SITE BACKGROUND INFORMATION

### 2.1 Site Description

An overview of the subject site is provided below in Table 1.

**Table 1: Description of Subject Site**

Existing Environment	Comments
<p><b>Location Description</b></p>	<p>The subject site is located approximately 12.5 km north-east of Murwillumbah within the Tweed Shire Local Government Area of northern NSW.</p> <p>The subject site lies within the locality of Eviron, with the Stage II section of haul road and the SCRRC located within the adjacent Stotts Creek (the sites are located on the locality boundary). Access to the subject site is via the sealed entrance to the former Quirks Quarry from Eviron Road.</p> <p>A former narrow unsealed road or track currently exists between the subject site and SCRRC; however it is unsuitable for a haul road due to it being flood prone, narrow, and unstable for continuous heavy truck movements.</p> <p>The proposed new haul road would generally follow the route of the old road for approximately half the route length, before veering off and being located within undeveloped cleared land.</p>



Existing Environment	Comments
Existing Land Use	Stage I works would be undertaken entirely on Lot 1 DP1159352 however access to the subject site from Eviron Road will be required from surrounding TSC land being Lot 1 DP34555.
Surrounding Vegetation	<p>Approximately 55% of the subject site has previously been cleared of native vegetation and now exists as grassland. The lower slopes are predominantly cleared and contain areas of sugar cane or open grassy areas with isolated trees. The upper slopes and ridges along the western boundary are vegetated, as are the hills to the south and the area immediately adjacent to the eastern side of Quirks Quarry.</p> <p>Lot 1 DP34555, the central southern lot adjoining Eviron Road, contains only scattered vegetated areas. The existing unsealed track to Quirks Quarry traverses this parcel of land. Refer to Figure 1 for aerial view of subject site and the proposed haul road alignment.</p>
Waterways and Drainage Pathways	<p>Overland flow within the subject site generally flows in a northerly direction to a constructed cane drain located on the adjacent northern private property. This cane drain flows in a circuitous route to the Tweed River and is managed via a floodgate.</p> <p>Water quality within the upper reaches of the constructed cane drain is generally poor with little flushing due to its location within the upper reaches of the catchment.</p>
Geological setting (slope/landform/soil class)	The low lying areas (under cane production) are mapped as the marine plain of lower Tweed catchment consisting of deep Quaternary alluvium and estuarine sediments. Local relief is typically <1m; elevation ranging from 0-3m and long slopes of <3% (Morand 1996).

## 2.2 Local Soils and Constraints

### 2.2.1 Soil landscape Mapping

As identified in Soil Landscapes of Murwillumbah –Tweed Heads 1:100000 Sheet (Morand, 1996) the proposed haul road is located at the interface of two soil landscapes being the Burringbar Landscape (bu) and the Tweed Landscape (tw).

The Burringbar soil landscape is an erosional landscape associated with elevated land consisting of high rolling to steep hills on metamorphics of the Neranleigh-Fernvale Group.

Relief is typically 100m to 200m with long slopes of ranging from 400 to 750m in length with grades of 15 to 33% (Morand 1996). Soils are variable within the landscape dependant on their elevation and location within the landscape. Shallow (0-100cm in depth) stony grey earths are typically found on crests and ridgelines. Red and Yellow Podzolics are found on hillslopes dependant on underlying mineral composition, with Red earths found on foot-slopes and lower slopes. Soils of the Burringbar landscape are erodible, strongly acid, hard setting and dispersive soils (Morand 1996).

The Tweed soil landscape is an estuarine/alluvial landscape that forms the marine plain of the lower Tweed Catchment. The landscape comprises deep Quaternary alluvium and estuarine sediments. Relief is typically <1m with elevations ranging from 0 to 3m. The marine plain has been totally cleared of native vegetation and now exists and agricultural land used predominantly for sugar cane production. Soils are generally deep (>200cm) poorly drained Brown Alluvial clay on levees that overlie the poorly drained Humic Gleys at depth across the greater floodplains. Soils of the Tweed landscape are typically impermeable and generally waterlogged, highly acid with extensive occurrence of acid sulfate soils, and have a low wet bearing strength hazard (Morand 1996).

### **2.2.1 Constraints**

Morand (1996) identifies the main limitations of the low lying soils within the subject site as subject to flood inundation, a permanently high groundwater table, low permeability of subsoils and potential acid sulfate soils (ASS).

The 1:25,000 NSW ASS Planning Maps identify the subject site as being within a Class 2 and Class 5 ASS mapped area. From a development perspective a Class 2 area would require additional investigations if works were undertaken below the natural ground level, or where the water table is likely to be lowered. As the proposed works involve the filling of land rather than the excavation of land, the disturbance of ASS's is considered unlikely at a large scale. However some minor works such as drainage works and the construction of temporary sediment basins for the purpose of erosion and sediment controls may disturb ASS. Where disturbance such as excavations below ground level would be undertaken within the Class 2 mapped area, an assessment would be undertaken to determine appropriate management measures.

## **2.3 Imported Material**

### **2.3.1 Waste Classification of Material**

In order to construct the haul road as per the approved design, approximately 25,000 cubic metres of material would be imported to the subject site. Importation of material would be a staged process as suitable surplus material from TSC operational projects becomes available.

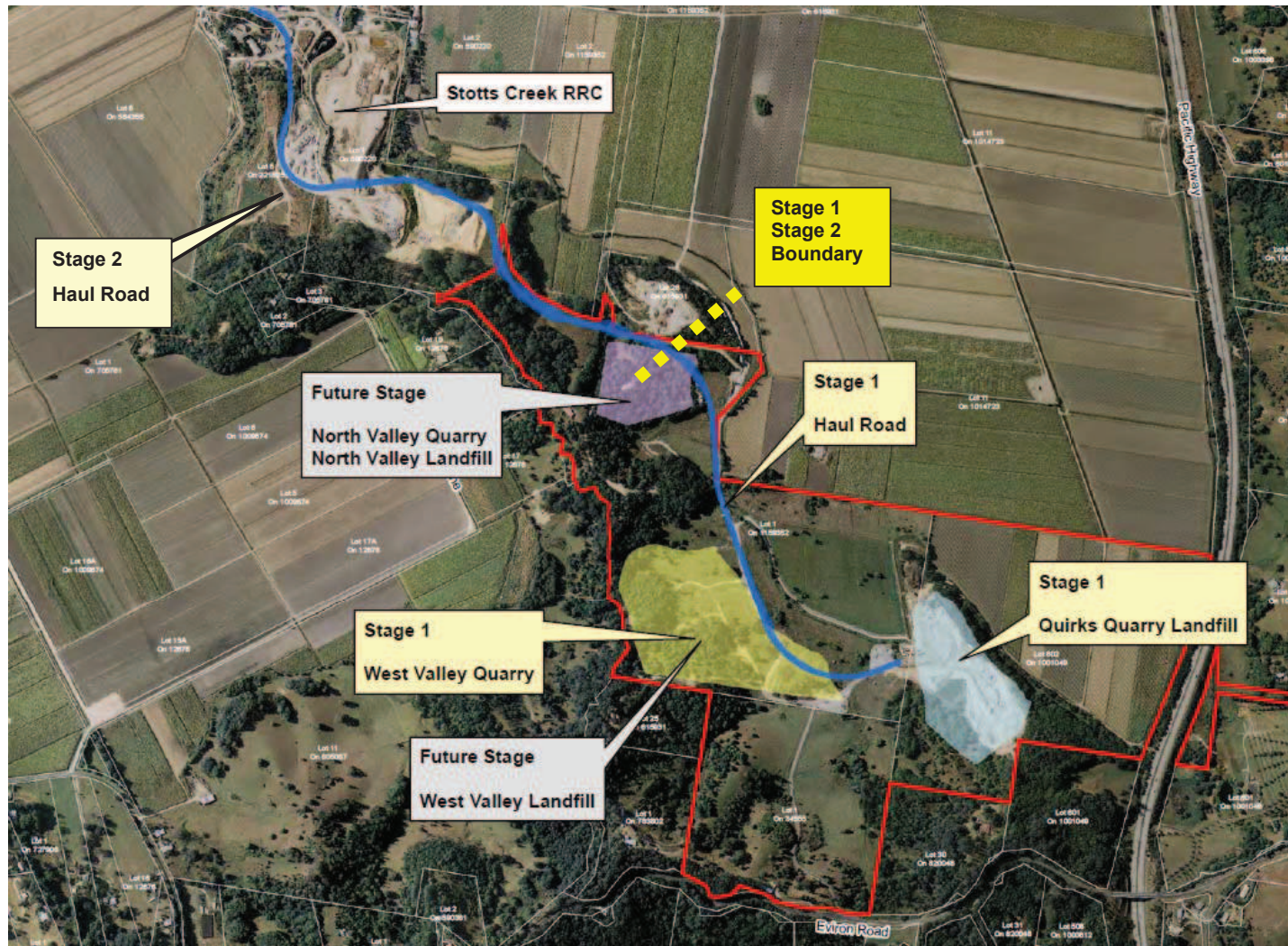

Figure 1: Location of proposed Stage 1 and Stage 2 haul roads and immediate surrounds. Source: GHD 2010

**This Page is Blank**





Material	Description	Date of Exemption/Order
	limited to materials such as sandstone, shale, clay and soil) that has: <ul style="list-style-type: none"> <li>• been excavated from the ground, and</li> <li>• contains at least 98% (by weight) natural material, and</li> <li>• does not meet the definition of Virgin Excavated Natural Material (VENM) in the Act.</li> </ul>	2014
<b>TSC</b> <b>EPRM</b>	<p><b>Excavated Public Road Material</b></p> <p>Is waste material, being rock, soil, sand, bitumen, reclaimed asphalt pavement, gravel, slag from iron and steel manufacturing, fly and bottom ash, concrete, brick, ceramics and any materials that hold a resource recovery exemption for use in road making activities and that have been excavated during the construction and maintenance of council and RMS public roads and public road infrastructure facilities. This does not include any waste that contains coal tar or asbestos, or any waste that is classified as hazardous, restricted solid, special or liquid waste as defined in the POEO Act 1997.</p> <p><b>Note:</b></p> <p><b>The TSC EPRM Exemption is only permissible for works undertaken on Lot 1 DP1159352 from 1 June 2016 to 30 May 2018.</b></p>	2016

Suitably classified material imported to the subject site will only be accepted with appropriate documentation stating material has been classified and meets the above waste classification definitions.

### 2.3.2 Characteristics of Imported Material

It is likely that the bulk of the imported material would be sourced from within the Tweed Shire; however it is also feasible that material may be sourced from outside of the shire. As soils would be sourced from varying soil landscapes, the properties and characteristics of the imported soils will differ and therefore will need to be considered for site specific erosion and sediment controls. For the purpose of designing a robust SWMP for the construction of the haul road, characteristics of dispersible soils would be adopted in the development of the SWMP. From a constraints perspective fine textured clay soils with a high soil erodibility factor or “K” factor, are a major consideration for the subject sites erosion and sediment controls.

As stated within the Blue Book (Landcom, 2014) sediment basin(s) must be constructed where the calculated total annual soil loss from disturbed lands is greater than 150 cubic metres. In determining the approximate total annual soil loss for the footprint of the haul road corridor, a selection of soil landscapes from within the shire were considered. Based on the characteristics of these soils, the annual soil loss was calculated using the Revised Universal Soil Loss Equation (RUSLE) listed below in Equation (1). Refer to Table 3 for the initial soil characteristic adopted for the haul road project.

$$A = R K L S P C \dots\dots\dots \text{Equation (1)}$$

- where,
- A = computed soil loss (tonnes/ha/yr)<sup>[1]</sup>
  - R = rainfall erosivity factor
  - K = soil erodibility factor
  - LS = slope length/gradient factor
  - P = erosion control practice factor
  - C = ground cover and management factor.

**Table 3: Adopted Input Parameters for the Revised Universal Soil Loss Equation**

PARAMETER	FIELD CONDITION OR VALUE
Rainfall erosivity	7200 (based on R Factor maps – App B, Blue Book) 5840 as calculated from Rainfall Data (see sediment basin calculations in App.D)
Rainfall Zone	Zone 1 (Figure 4.9 Rainfall Distribution Zones, Blue Book)
Area of Disturbance	Approx. 2 ha for the haul road corridor that includes both road pavement and batters.
Slope gradients	Haul Road: Long sections of roads < 10%. Batters: up to 66%, an equivalent grade of 1:1.5.
Slope lengths	Road: < 80m. Batters: typically 4 to 6m.
Slope Length/gradient factor	Road: slope length of <80m, gradient <10% = factor of 2.81. Batters: slope length of <6m, gradient <66% = factor of 3.33.

PARAMETER	FIELD CONDITION OR VALUE
(LS)	Determined from Table A1 App. A of Blue Book.
Soil Erodibility (K Factor)	<p>Variable dependant on characteristics of imported soils eg low to high. Morand (1996) lists K factors of soils within the Tweed as ranging from approx. 0.01 for Type C or coarse soils, to &gt;0.09 for Type D or dispersible soils.</p> <p>In the absence of site-specific data the adopted K factor for the subject site is, 0.055.</p> <p>Although this value is not considered a worst case scenario it is considered as representative of material that may be imported to subject site. Where operational projects would provide high volumes of suitable road building material, sediment basins would be recalculated based on site specific soil characteristics/data that may increase or decrease the annual soil loss value for the specific section (catchment), or length of haul road and its dedicated sediment basin.</p> <p>Where feasible the sediment basin design and volume may be reduced or increased dependent on the K factor of the imported material.</p>
Erosion Control Practice factor (P)	<p>Default value of 1.3 for smooth and compact soil surface.</p> <p>Determined from Table A2, App. A of Blue Book.</p>
Ground Cover Management Factor	<p>Default value of 1.0 for soils recently stripped of vegetation ie no cover</p> <p>Determined from Figure A5, App. A of Blue Book.</p>
Calculated soil loss	<p>Estimated soil loss for total area of disturbance.</p> <p>An estimated worst case was calculated for soil loss based on:</p> <ul style="list-style-type: none"> <li>• an approx. road formation surface area of one hectare with a maximum road formation slope of 10%, and a maximum road formation slope length of &lt; 80m.</li> <li>• an approx. roadside batter area of one hectare with a maximum slope grade of 66%, and a maximum slope length of 6m.</li> </ul> <p>The combined total soil loss was calculated at 1936 cubic metres/ha/year. Soil loss values that are &gt; 1500 tonnes/ha/year are rated as soil loss class 7, and considered an extremely high erosion hazard.</p>



PARAMETER	FIELD CONDITION OR VALUE
	Control measures will ensure that the soil loss class is less than <1500 cubic metres/ha/year which is equivalent to a Class 6 or very high erosion hazard
Potential Erosion Hazard	Road: very high to extremely high Batters: > extremely high Controls would be installed to ensure the maximum hazard rating is very high.
Volumetric Runoff Coefficient (Cv)	In determination of sediment basins a Cv value of 0.58 for a soil hydrological group C and a design rainfall depth of 41-50mm. Determined from Table F2, Appendix F of Blue Book.
Are sediment Basins required?	As the calculated soil loss exceeds 150 tonnes/ha/year for the subject site sediment basins will be required.  Where soils of more than one type are present within a specific catchment along the haul road corridor, sediment basins would be designed to meet the most stringent criterion applicable.  For the purpose of the haul road, Type D basins will be constructed to manage potential dispersible soils imported to the subject site.

From the above data the potential soil loss was calculated (using RUSLE).at 1936 cubic metres /hectare/year (combined for road formation surface area and batter areas). This equates to a Soil Loss Class 7, which is considered as an extremely high erosion hazard. To reduce the soil loss class from 7 to 6, the placement of control measures shall be at a distance of less than 80m eg install road surface controls such as mulch or coir logs or shallow cut-off drains at 40m intervals along road formation.

Where the calculated soil loss values are >150 cubic metres/hectare/year, the construction of sediment basins are required to manage sediment loss and capture turbid (construction) water. Refer to section 5.4 for sediment basin type and the calculated volumes of individual basins.

### **3 SOIL AND WATER MANAGEMENT PLAN**

#### **3.1 TSC Development Design Specification- Stormwater Quality**

The TSC Design Specification D7 Stormwater Quality prescribes stormwater quality measures to be adopted for development which includes any land development or use which may impact on the quality of runoff and drainage discharging from the subject site to any natural or artificial waterway or water body. All erosion and sediment control plans (ESCPs) or SWMPs must adopt and incorporate the Code of Practice for soil and water management on construction works. The primary reference manual for the code of practice is the Blue Book (Landcom, 2004). A copy of the code of practice is located in Appendix B of this SWMP.

The Code of Practice states that the aims of erosion and sediment controls should be to:

- Minimise soil erosion and exposure.
- Minimise transportation of eroded soil by air and water.
- Limit suspended solids (soils) concentration in storm-water to < 50mg/L.
- Limit and minimise the amount of site disturbance.
- Isolate the site by diverting clean upstream “run on” water around the development.
- Control runoff and sediment at its point source rather than at one final point.
- Stage ground disturbance/earthworks and progressively revegetate disturbed areas where possible to reduce the area contributing sediment.
- Retain topsoil for vegetation works.
- Locate sediment control structures where they are most effective and efficient.

This SWMP adopts the code of practice as a guiding document to achieve compliance.

#### **3.2 General Requirements**

The following general requirements shall be implemented across the haul road subject site inclusive of all individual catchments.

- An overview of the haul road construction area is presented in Figure 1. Erosion and sediment control measures would be progressively staged and relocated as material is imported to the subject site.
- Ensure all workers/contractors undertake soil and water management works as instructed in this document and following the guidelines in the Blue Book (Landcom, 2004).
- Inform all workers/contractors of their responsibility in minimising the potential for soil erosion and pollution to downstream areas.

- As works and stages progress, plans are to be updated, taking into consideration how to minimise areas of disturbance at any one time, characteristics of imported soils in relation to control measures, and stabilising disturbed areas ASAP. Refer to Section 5.6, Review and Improvement of SWMP.
- Surface flows and runoff generated from the undisturbed areas located upstream or west of the haul footprint will be clean water. This clean water can be diverted into local watercourses located on the eastern side of the haul road via existing and proposed new larger piped culverts within the base of the raised haul road. Construction water (sediment laden runoff) will be segregated from clean run-on water and would be diverted into sediment basins for treatment prior to release or discharge.
- As imported material for the purposes of road construction would potentially be dispersive in nature, contained construction water within the Type D sediment basins would potentially require floccing to ensure water quality release criteria is achieved. Treated water within the sediment basins would then be pumped or drawn down within five days, prior to next rain event taking place.
- Where imported material differs in characteristics from adopted values listed in Table 3, control measures shall be reassessed to ensure they are suitable for the imported material (eg sediment basin sizing may need to be amended dependant on characteristics of sourced material).
- Ensure erosion and sediment controls remain in place until filled or disturbed areas are rehabilitated and successfully stabilised eg establishment of >50% cover grass/turf.
- Land disturbance across the subject site will be kept as low as possible with no works to be undertaken within defined no go areas.
- A water quality (WQ) monitoring program would be undertaken to ensure stormwater that is discharged from the subject site is within WQ discharge criteria. Refer to Section 5.2 for discharge water quality objectives (WQO). The monitoring programme would include;
  - reporting procedures,
  - the frequency and triggers of site compliance audits,
  - discharge quality standards ,and
  - response to any non-compliances

### **3.3 Schedule of Works**

Installation of erosion and sediment control measures will take place prior to commencement of site works. Reference to standard drawings (SD) relates to SD and designs from the Blue Book (Landcom, 2004). Common standard drawings proposed in this SWMP are listed in Appendix C.

Construction of the haul road will require approximately 25,000 cubic metres of imported soil to ensure the road is flood free and has a maximum grade of <10%. As the main constraint to the construction of the haul road would be the availability of surplus suitable material, the project would be staged until completion.

In order to achieve a minimum disturbance within the haul road footprint the following staged process is proposed.

- Access to the subject site would be restricted to one location, being the existing entry point to the former Quirks Quarry via Eviron Road, Eviron. Once within the operational land all vehicle movements will keep to the existing formed internal access roads to minimise additional areas of disturbance. Internal access roads would be maintained and repaired as necessary to ensure road is stable and operational.
- Works would commence from approximately chainage (ch) 1010 the northern most end of the haul road and continue south decreasing in ch. values to Ch. 0000. The maximum length or chainage of the haul road footprint that would be disturbed at any one time would be inline with identified catchments and sediment basins. All construction water would be captured by a sediment basin; therefore the construction of each sediment basin will define the staging of works. Works would continue in that section or length of haul road until design levels are achieved, or to a stage that stabilisation works can be undertaken to that individual section or catchment.
- Due to the intermittent nature of importing material and the likely scenario of an intermittent site presence, it is likely that material would be stockpiled until a minimum volume is reached for spreading, rolling and compaction (application to land) that is considered cost effective. All stockpiles would be managed with any runoff water directed to a sediment basin for management prior to discharging. Where stockpiles would be idle for > 10 days they would be stabilised. Refer to Section 4.2 for stabilisation measures.
- Where stabilisation of individual catchments is achieved, sediment basins would be decommissioned with additional erosion control measures installed until disturbed areas (former sediment basin footprint) is stabilised.
- Works would continue along the length of the haul road until ch. 0000 is reached. Once complete the road pavement would be constructed in defined sections or lengths along the completed elevated haul road until completion.

### 3.4 Sequence of site controls

- The single site access point via Eviron Road would be a dedicated constructed entry and exit point. All vehicles would be directed over a vibration shaker grid prior to leaving the subject site and entering public roads.
- No go areas, or out of bounds areas would be flagged as **NO GO AREAS** by fencing or high visibility tape. Tape or flagging shall be assessed and replaced as per manufacturer's timelines/recommendations or as identified by a site audit or inspection.

- Surveyors will identify the haul road corridor consisting of the pavement width and external toe of batter at design RL. Surveyors will progressively identify the road corridor as works progress.
- Prior to works commencing the identified section, or works within the haul road footprint would be cleared and grubbed and topsoil where feasible removed and stockpiled for future use (eg to establish batter stabilising vegetation).
- In regards to ESC's, surveyors would additionally identify the footprint and placement of sediment basins for the relevant stage under construction, and progressively locate additional basins as works continue. Refer to Appendix D for sediment basin designs.
- A perimeter bund or earth bank (**SD5-6**) would be constructed to act as the perimeter catchment boundary to isolate clean upslope water from (sediment laden) construction water generated within the confines of the haul road corridor.
- Construction water generated from within the haul road corridor would be directed via controls (diversion bunds or windrows, batter chutes, dissipaters, check dams, low flow drains) to a Type D sediment basin, designed and sized for each identified catchment (eg SBW2 for catchment area ch.810 to ch. 725).
- Once perimeter diversion bunds, catchment drains and relevant sediment basins are constructed, stabilised and approved as operational, construction works for the haul road may commence. Refer to sediment basin operations for water management in Appendix E.
- As suitable imported material is imported to subject site it will be placed within surveyed haul road footprint ready for spreading and compacting. If however an excess of fill is supplied ahead of spreading and compacting works it would be placed within a dedicated stockpile area with erosion controls as per (**SD4-1**).
- Stabilise surfaces disturbed by construction works as soon as final design levels are established. Refer to Appendix E for stabilising vegetation guidance.
- Conduct regular monitoring of erosion and sediment control measures to identify problems or maintain various measures as required. Refer to Section 5 for maintenance and monitoring schedules.
- If conditions deteriorate due to inclement weather, high rainfall events or failure of site controls, the subject site would be closed until such time as favourable site conditions return or site control measures are repaired, or improved, and reassessed as operational.

## 4 EROSION & SEDIMENT CONTROL MEASURES

### 4.1 Erosion Controls

The following erosion control measures would be implemented during the construction phase of the haul road project. Refer to Appendix C for standard drawings and examples of control measures.

- The soil erosion hazard across the subject site would be kept as low as practical by staging works and minimising the overall area of disturbance at any time. Management measures would include:
  - Staging of works eg working in an orderly sequence from ch. 1010 and decreasing to ch. 0000.
  - Access within the subject site would be limited to the confines of the haul road footprint/corridor and existing formed access roads within the greater site area.
  - Establishing barrier fencing for no go areas
- Stockpiles are to be sited at least five metres from areas of likely concentrated or high-velocity surface water flows, especially diversion drains and internal access roads (including road drains).
- During windy weather, unprotected areas (including haul roads) would be kept moist (not wet) by spraying with water (eg water tanker) to reduce wind erosion, or use an alternative spray-applied wind-erosion control measure.

### 4.2 Stabilisation Measures

Where practicable complete entire sections or identified catchments of the haul road so that the time from commencement to completion of the final rehabilitation program is less than six months.

- When rehabilitating surfaces whether temporarily or permanently, soils would be left with a loose surface to encourage water infiltration and the establishment of a stabilising groundcover.
- Once land shaping is completed for each stage, stabilisation would be undertaken as soon as possible in line with adopted measures of Table 4. Table 4 states maximum acceptable C-Factors (cover factor) for both the construction and post construction stage
- During times when the subject site is closed, such as times where no suitable material is available, disturbed areas would be stabilised as soon as possible in line with guidance material listed in Appendix F.
- Native Vegetation cleared from the subject site would be coarsely mulched and stockpiled for later re-use as a protective ground cover during rehabilitation

works or as a temporary ground cover for cleared areas until they are ready for stripping.

- Revegetation areas would be watered regularly until an effective vegetation cover has established and areas are growing vigorously.

**Table 4: Maximum acceptable C-factors at nominated Times during works**

Lands	Maximum C-Factor (Cover-Factor)	Remarks
Waterways and other areas subjected to concentrated flows, post construction	0.05	The cover-factor applies after ten working days from completion of formation and before they are allowed to carry any concentrated flows. Flows will be limited to those shown in Table 5.1 of Landcom (2004). Foot and vehicular traffic will be prohibited in these areas (70% ground cover).
Stockpiles, post-construction	0.1	The cover-factor applies after ten working days from completion of formation. Maximum C-factor of 0.10 equals 60% ground cover,
All lands, including waterways and stockpiles during construction	0.15	The cover-factor applies after 20 working days of inactivity, even though works might continue later. Maximum C-factor of 0.15 equals 50% ground cover,

Table Notes

C-Factor of 0.05, approx. 70% ground cover for Turf

C-Factor of 0.1, approx. 60% ground cover for Turf

C-Factor of 0.15, approx. 50% ground cover for Turf

C-Factor of 1.0, bare stripped earth

- To achieve successful stabilisation and revegetation of disturbed land requires consideration of the following factors is required:
  - correct site preparation
  - selection of the most suitable establishment technique
  - appropriate soils such topsoils to establish grass, and annual crops
  - selection of appropriate plant species, fertiliser(s) and ameliorant(s)
  - application of sufficient water for germination and to sustain plant growth if rainfall is insufficient eg use of water truck
  - an adequate maintenance programme.



- Lands that are subject to sheet flows such as steep constructed batters would typically stage the establishment of stabilising vegetation via:
  - Primary revegetation which is designed to reduce the erosion hazard to an acceptable level rapidly. Vegetation includes use of annuals where a quick, temporary cover is required (for up to about six months), and perennials for long term protection; and
  - Secondary revegetation follows primary vegetation with the establishment of permanent endemic/native species; however species can be established at the same time. Establishment can be from seed, tube stock or invasion from the surrounding native bushland species.

Refer to Appendix F (Vegetation Stabilisation) for additional guidance. Note that for batter slopes of 66%, options are reduced for successful stabilisation.

### 4.3 Sediment Control

The following sediment control measures would be employed across the haul road construction areas:

- Sediment fencing (or a similar alternative control) would be installed at the toe of the constructed batters. The purpose of the sediment fence is twofold (i) to form the external perimeter or toe of the constructed batter, and prevent imported material spilling down slope into low flow perimeter drains, and (ii) manage and trap sediment from the action of sheet flow down the constructed road batters. The constructed batters would progressively become steeper (up to 66% grade) as construction works reach design levels. Sediment fencing would be installed in-line with **SD6-8** and Figure 3.
- Cross-fall of the constructed road surface would be to the south from approx. ch 0-400 and west from approx. ch. 400-1010. As construction works progress an earthen windrow or earthen bund would be constructed along the top of the batter/outside edge of road. The purpose of the bund is to divert stormwater to constructed batter drop down chutes that would divert sheet and concentrated flows off the batter face.



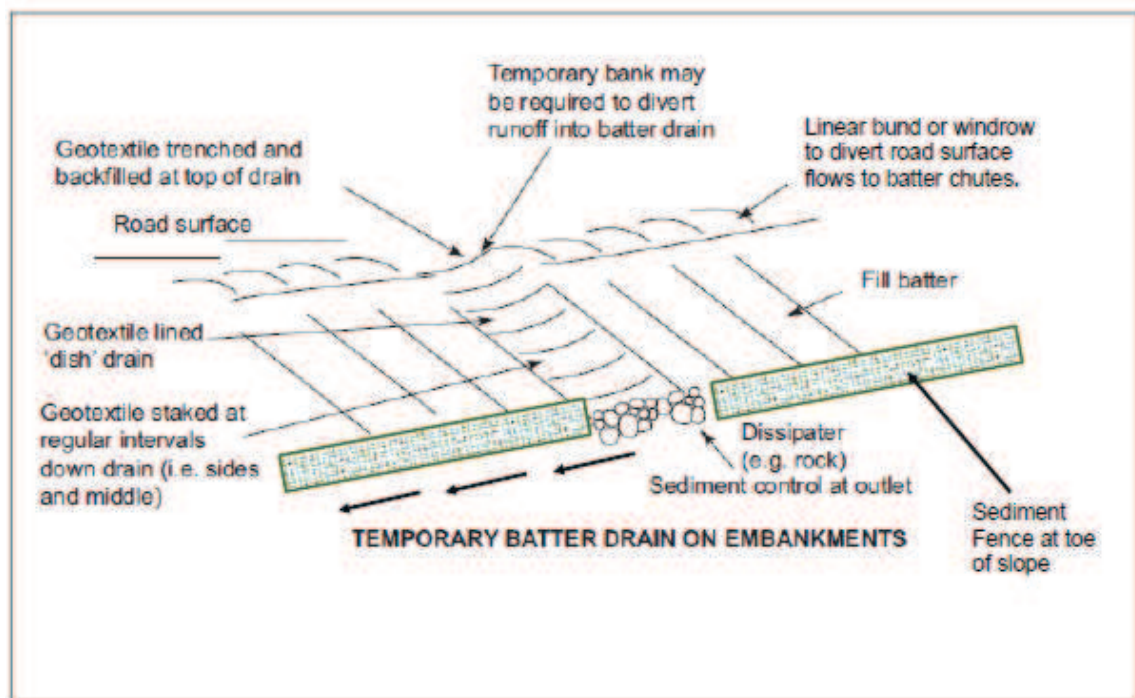

**Figure 3: Typical temporary controls for constructed haul road batter.**

- Due to the length of haul road, the haul road project has been split into multiple catchments to manage both sediment and rainfall. At identified locations catchment boundaries would be installed prior to rain events via the use of diversion controls such of sandbag strips, filled geo-fabric sausages (socks) or by cutting or ripping a cross-fall diversion drain.
- Prior to rainfall the length of road surface slopes shall be reduced to a maximum distance of 40m to reduce sheet flow velocity and capture sediment. Slopes can be easily reduced prior to rainfall via cutting or ripping contour lines within the surface, or by installing sand bags strips, filled geo-fabric filter sausages (socks) or other similar products.
- Where windrows or low earth bunds direct flows down batter chutes, rock dissipaters (or similar) would be installed to reduce concentrated flow velocities discharged from the chute. Flows would then be directed along the lined low flow drain (trapezoid or parabolic shaped) to the catchments dedicated sediment basin.

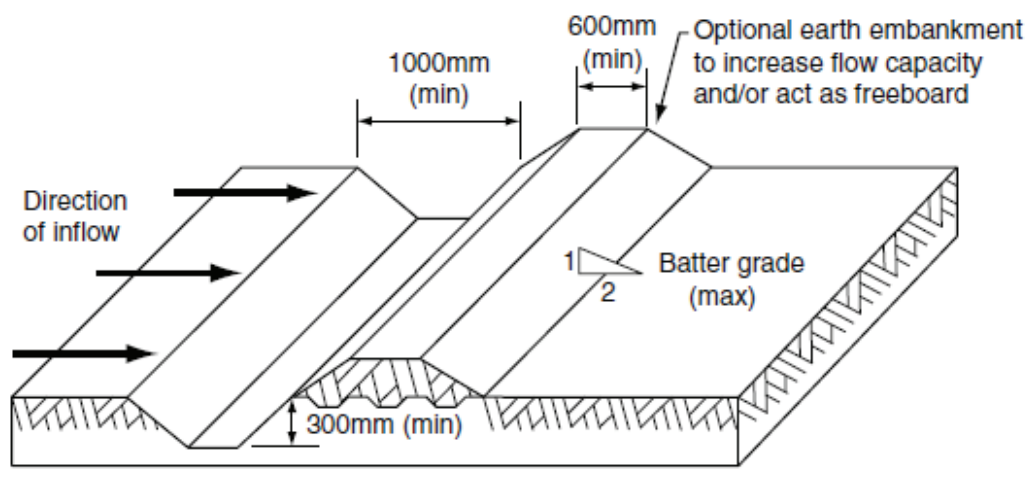

**Figure 4: Typical diversion drain concept to isolate clean water and construction water.**

- Sediment trapped as a result of installed controls (eg sediment fences or sediment basins), and within drains, would be regularly removed as part of ongoing monitoring and maintenance. Sediment would be removed and reused where possible. Refer to Section 5 for monitoring and maintenance.

#### 4.4 Sediment Basins

Sediment basins are proposed to capture both sediment and stormwater flows generated from within the haul road construction area. As soils imported to the subject site will be variable in characteristics eg course sediment to fine dispersible clay soils, sediment basins would be constructed based on the likelihood of managing dispersible (Type D) soils, (ie where 10 % or more of the soil materials are dispersible). Sediment Basins would be constructed to Type D specifications as per the intent of SD6-4.

Where it can be demonstrated that a large volume of imported material with type C (course sediment) or type F (fine sediment) characteristics, with a reduced erosivity factor ie  $<0.055$ , the sediment basin for that catchment could be resized (reduced in volume) to reflect such characteristics. Alternately, if soils with a very high erosivity were considered for haul road construction, its characteristics should be assessed to determine if material is suitable for construction purposes, and if the sediment basin for that catchment should be increased in volume to cater for soil variability. Additionally, if catchment areas increase or decrease, the basin capacity can be adjusted to adapt to such changes.

The capacity of each sediment basin is the sum of two components;

- (i) A settling zone, within which water is stored allowing the settlement of suspended sediment. The settling zone is designed to capture most sediment in a nominated design rainfall event and, in turn, a specific discharge water quality.

- (ii) A sediment storage zone, where trapped sediment is stored until the basin is cleaned out, or for the life of the project where land disturbance is of a short duration (<two months).

The sediment basin would have any accumulated sediment removed when its design capacity is reached. Design capacity is the calculated sediment storage zone for each sediment basin (refer to appendix D for sediment basin sizing and calculations). A vertical stake or depth marker would be installed within each sediment basin to identify the upper limit of the sediment storage zone to provide a visual indicator of when sediment capacity is reached.

The adopted design specifications as listed previously in Table 3 were used for sediment basin calculations. In determining catchment areas the following parameters were considered:

- During the construction stage cross-fall of the haul road will be to the same side of the road for its entire length ie the southern side of road from approx. ch 0-400 and western side of road from approx. ch. 400-1010 (where the alignment of the haul road changes direction). All sediment basins that have west within the description have been sized to include both the road surface and the western or southern batter. Sediment basins with east within the description have been sized only for the eastern or northern batter. Refer to Appendix A for plan views of the haul road catchments and associated sediment basins.

**Table 5: Adopted Sediment Basin Design Criteria**

Control Measure	Duration of disturbance for individual catchments 6-12 months with a receiving environment of standard sensitivity
<b>Temporary Drainage Controls</b> eg diversion banks, perimeter banks, catch drains, level spreaders, check dams, batter drains and chutes.	5 Years
<b>Temporary Sediment control Measures</b> Eg sediment fences, check dams, sediment traps	5 Years
<b>Type D Sediment Basins</b>	80 <sup>th</sup> percentile
<ul style="list-style-type: none"> <li>• designed to achieve required water quality for storms up to nominated five-day duration percentile event.</li> </ul>	
<ul style="list-style-type: none"> <li>• Embankment and spillway designed to be structurally sound (indicative only - consider the risks of basin failure for each basin to determine appropriate spillway design flow).</li> </ul>	20 Years

Table Notes

Criteria listed above from Table 6.1 Managing Urban Stormwater Volume 2D Main Roads (2008)

- Constraints to construct sediment basins include areas of relatively flat or very low grades combined with low lying areas identified with potential ASS's. As excavations into ASS's are not encouraged the depth of excavations would potentially be limited. Therefore, sediment basins would be confined to in some areas to surface construction, which would significantly affect the basins capacity. If sizing of sediment basins are constrained in size or volume the associated catchments would also need to be reduced in size. This would effectively create more basins along the haul road corridor. However, where it is considered that minor excavation into ASS material cannot be avoided an ASS Management Plant for such works would be required.
- Increased sediment basins would require increased time in managing and maintaining each basin, and treating and managing the trapped construction water prior to discharge.
- Ensure that soils used for the construction of the sediment basin are suitable for such purpose and do not pose a risk for dam failure. Characteristics of unsuitable soils include (but are not limited to) soils susceptible to tunneling or piping, permeable soils, and soils with a high shrink swell potential.

## 4.5 Water Management

All stormwater runoff (construction water) generated from within the haul road footprint would be directed to a sediment basin for that specific sub catchment of the haul road. Each individual basin would be treated and then drained or pumped out within the adopted five day management period following rainfall (ie rainfall of sufficient depth to result in surface runoff entering the basin). This rainfall depth will vary depending on the site conditions at the time of the event, the extent of any impervious surfaces (e.g. road surface or batters) and the extent of preceding rainfall.

Management of Sediment Basins based on Type D or dispersible soils include:

- Basins that capture runoff from Type D soils would be drained or pumped out within the time period adopted in the design of the basin (5 days, as site conditions allow) following rainfall if the nominated water quality targets can be achieved. Flocculation would be employed where extended settling of fine clay particles is unlikely to meet the adopted WQO's
- Floccing of the captured construction water would typically be undertaken with a chemical agent to reduce the settling time of clay fines within the stormwater. Refer to Appendix E for water management.

- Release of treated stormwater would only be undertaken where the captured and treated water meets the required discharge criteria of 50mg/L for total suspended solids (TSS) and a pH within the range of 6.5 to 8.5.
- An alternative to discharging treated stormwater to the receiving environment (eg local drainage lines feeding to cane drains and creek) is use of water for construction purposes such as a water truck for dust suppression or compaction requirements. Additionally, treated water could be used for watering of seeded batters, or general landscape irrigation to establish grass and other vegetation. Prior to use of water for irrigation the water quality should be assessed to ensure it is fit for purpose (eg consideration of water salinity and pH).

#### 4.6 Monitoring of Weather Conditions

Planning and being prepared for impending rainfall or large scale events such as east coast lows can only be undertaken via an awareness of weather forecasts. By monitoring the 24 to 48 hour 7 day weather forecast ESC measures can be planned and installed with enough lead time to protect and manage disturbed areas.

During months of the year that are considered a high risk for construction works, especially where the potential soil loss is a class 6, special erosion control measures are required based on seasonal months where there is a high risk of significant rainfall erosivity. Table 6 below lists the months where erosivity is considered a high risk for earthworks in relation to a class 6 soil loss. Note that class 6 is calculated based on the potential of dispersible soils imported to the subject site; however soil characteristics will be variable with the soil loss class generally likely as < class 6.

**Table 6: Months where special ESC measures are required**

Soil Loss Class 6	Special Measures Required?
January, February, March, April, May Second half of November, December	Yes
June, July, August, September, October First half of November	No, not required

Table Notes

- Identified Months identified from Table 4.3 of Blue Book.
- Where scheduling activities on highly sensitive lands in periods when rainfall erosivity is low, or is impractical, ensure that any disturbed lands have C-factors higher than 0.1 only when the 3-day forecast suggests that rain is unlikely. In this case, management regimes should be established that facilitate stabilisation within 24 hours should the forecast prove incorrect.

In regards to monitoring of weather conditions and minimum ESC measures, Table 7 provides examples of the minimum controls measures required.

**Table 7: Expected controls for weather conditions (adapted from Witheridge, 2010)**

Forecast Weather Conditions	Erosion & Sediment Controls (ESC's)
No rain or strong winds expected	<ul style="list-style-type: none"> <li>• If favourable dry weather conditions are forecast (eg based on the 24 to 48 hour weather forecast) , avoid unnecessary expenditure of time on excessive ESC's; however ensure the subject site is prepared (action plan and controls ready) for unseasonable weather conditions.</li> <li>• Sediment controls at the subject site entry/exit are always required (eg stabilised entry)</li> </ul>
Light Rain	<ul style="list-style-type: none"> <li>• ESC's measures are used to maximise filtration of sediment laden water especially during times of light rain rather than high surges/flows during heaving rain.</li> <li>• Discharges of construction water to local waterways have a higher potential to create pollution during low rainfall as water quality will be high in creeks, in contrast to high flow events where water quality is typically poor. Therefore, it is critical that ESC's are effective at all times with stormwater directed to sediment basins.</li> </ul>
Moderate to Heavy Rain	<ul style="list-style-type: none"> <li>• Cease work and close site</li> <li>• Ensure effective control measures are in place to prevent formation of rills or gullies.</li> <li>• Ensure controls are operational (eg sediment removed and structurally sound )</li> <li>• Ensure monitoring of controls during extended rainfall events to mitigate offsite impacts</li> <li>• Undertake additional inspections during and/or immediately following significant rainfall events to monitor the functioning of controls.</li> </ul>
Strong Winds	<ul style="list-style-type: none"> <li>• Ensure ESC's are appropriately anchored</li> <li>• Maintain soil surfaces in roughened condition to reduce dust</li> <li>• Use water truck where necessary or alternatively soil stabilisers</li> </ul>

## 5.0 INSPECTION, MONITORING AND AUDITING

The intent of inspection, monitoring and auditing is to fulfil the principles of sound soil conservation practice as detailed within this SWMP and referenced guiding documents.

A proactive and preventative philosophy is adopted as per the code of practice (refer to Appendix B) rather than a reactive approach, to the control of erosion and sedimentation.

### 5.1 Site Inspection and Monitoring

In an effort to ensure erosion and control measures are in place and functional prior to any rain events, constant monitoring of weather forecasts, especially local weather radar (eg Australian Bureau of Meteorology website) would be undertaken. With adequate warning of impending rainfall or windy conditions control measures can be implemented and reviewed as per the examples of Table 7. The following measures are proposed to undertake the minimum site inspections and monitoring at the haul road construction site. Additional maintenance measures are listed in Section 8 (Maintenance), of the Blue Book (Landcom, 2004).

- A rain gauge would be installed and monitored on a daily basis to ensure rainfall at the haul road site is recorded. It would be the responsibility of the site supervisor to maintain a daily diary to record daily rainfall and observations. If an automated weather station (tipping bucket gauge) was installed any storm event could be classified with data used to assess the construction sites performance against such storm (eg 5 year storm event, compared to the capacity of individual sediment basins).
  
- It shall be the responsibility of the site supervisor to inspect the sites erosion and sediment controls:
  - After each rainfall event
  - Before the end of the days shift with rainfall forecast
  - And at a minimum, on a weekly basis. However as staging of works progress vigilance for the efficacy of all controls shall be continuously monitored.
  
- Ongoing inspections and maintenance of the haul road construction site would include the following typical items to ensure that:
  - Barrier fencing and no go areas are taped off and maintained as out of bound areas with no infringements into these areas.
  - Disturbed areas are rehabilitated and stabilized ASAP as works progress. Stabilisation of areas may be at the completion of works (eg where final design levels achieved), or where staging is proposed and works will cease in an area due to no available fill material.
  - No tracking of mud off-site onto public roads is taking place
  - Erosion and sediment control measures are maintained and functioning as per their intent.



- Trapped sediment is removed from operational sediment controls and disposed of to a suitable area.
  - Stockpiles have control measures in place, are stabilized (if not used for >10 days), are protected from run-on storm-water and not sited within retained vegetation or within concentrated flow paths.
  - Perimeter drains, batter chutes and diversion drains are unobstructed and not experiencing scouring of base or side walls
  - Drainage structures such as sediment basins and spillways are structurally sound and operational.
- Inspections would be documented in the weekly or detailed inspection sheet. Refer to templates in Appendix G.
  - At the completion of each stage, defined as the completion of each individual catchment, regularly inspect revegetation areas, investigate failures and replant problem areas as necessary. Additionally, ensure that adequate watering, and where necessary fertilizer, is applied to establish a stabilised ground cover such as grass or turf.
  - Site inspections/audits would take place on a regular basis (at the frequency outlined below in Table 8) to ensure appropriate mitigation measures and controls are being provided and that they remain effective.
  - All inspection reports and non-conformances would be acted upon quickly and a written response provided within 7 working days detailing the action taken or proposed actions. Amendment to on-site controls will also be updated in this SWMP.

**Table 8: Site Inspection Frequency for Haul Road control measures**

Interval	Action
<b>Event Based</b>	<p>Site Inspections following rainfall resulting in runoff or discharge from site. Inspections to be undertaken by site supervisor or delegate</p> <ul style="list-style-type: none"> <li>● Inspection to assess whether sediment basins have received runoff and report findings to supervisor. Dependant on rainfall volume and preceding rain, directions would be provided in writing to treat contained stormwater and discharge or pump down clean water to local drainage line if conditional WQ criteria have been achieved. Refer to Appendix E for water management procedures of sediment basins.</li> <li>● Inspection as per site checklist (refer to template in Appendix G)</li> <li>● Inspections to inform the update of ESCPs and to identify where new controls are required as per the progressive nature of the haul road construction site.</li> </ul>



Interval	Action
<p><b>At end of days shift when rain is forecast</b> (when site <u>is</u> operational)</p>	<p>Informal visual assessments of erosion and sedimentation controls by the site supervisor or delegate prior to the end of the days shift when rain is forecast overnight or prior to non-work days (eg Sundays)</p> <ul style="list-style-type: none"> <li>• Monitor 7 day forecast, especially 24-48 hour rain forecast to ensure controls are in place and operational prior to any forecast rain and at end of shift.</li> <li>• Inspection as per site ESC daily inspection record sheet when rain is forecast.</li> </ul>
<p><b>Non Operational</b> (when site is <u>not</u> operational, eg fill material not available site closed)</p>	<p>During times when the site is closed due to no suitable fill material available a site presence is required to ensure erosion and sediment controls are maintained and functional, and that the management of sediment basins continues to meet WQO's.</p> <p>Ongoing site inspections by site supervisor or delegate would continue to be undertaken as per event based monitoring. Inspections would:</p> <ul style="list-style-type: none"> <li>• Assess whether sediment basins have received runoff and report findings to supervisor. Dependant on rainfall volume and preceding rain, directions would be provided in writing to treat contained stormwater and discharge or pump down clean water to local drainage line if conditional WQ criteria have been achieved.</li> <li>• Inspection as per site checklist.</li> <li>• Inspections to inform the update of ESCPs and to identify where new controls are required as per the progressive nature of the haul road construction site.</li> </ul>

## 5.2 Discharge Water Quality Objectives

Construction water discharged from the haul road site would meet the adopted criteria as listed below in Table 9. This accounts for any construction water whether intentionally discharged from a sediment basin, or as a result of sheet flows from standard erosion and sediment control measures such as sediment fences or turf filter strips.

Prior to release WQ shall be tested and documented as per protocols in Appendix E. It is noted that as soil characteristics have the potential to be variable the resultant WQ would reflect this variability from catchment to catchment along the haul road alignment. A water sample would be collected with the listed parameters (refer to Table 9) analysed, with either a handheld meter on-site, or forwarded to the Tweed Laboratory for analysis (where required).

Once initial sampling rounds have been undertaken it is proposed to correlate turbidity results in NTU and total suspended solids (TSS) in mg/L for the purpose of determining compliance as turbidity can be assessed immediately on-site. Laboratory analysis for TSS will be undertaken every 2 months (when possible) to enable the ongoing verification of the relationship between turbidity and TSS.

**Table 9: Adopted Water Quality Objectives for Discharge**

Parameter	Water Quality Objectives (adopted discharge criteria )
pH	6.5 to 8.5 pH units <sup>1,2</sup>
TSS (mg/L)	<50mg/L <sup>1,2</sup>
Turbidity	6-50 NTU <sup>2</sup>
Oil and Grease	Not Visible <sup>1</sup>

**Table Notes**

<sup>1</sup> Tweed Shire Council Development Design Specification D7 – Stormwater Quality

<sup>2</sup>Aquatic ecosystem criteria from Australian and New Zealand Environment and Conservation Council (ANZECC)(2000). *Australian and New Zealand Guidelines for Fresh and Marine Water Quality 2000* (Table 3.3.3 – Lowland rivers, and Table 3.4.1 – Freshwater criteria

**5.3 Auditing and Record Keeping**

Records of site inspections would be maintained and kept on file in a central location such as site office or TSC Project Management System. Items of inspections will include:

- Date of inspection
- Location of control measure or area of concern
- Defect
- Comments
- Action required
- Action completed

Refer to Appendix G for inspection templates. Any items of non-conformance will be actioned via the process set out in Section 5.4 (Non Compliance).

Typical considerations that would be undertaken during the course of an inspection would include:

- Are installed sediment fences adequate?
  - Are fences full of sediment (>60% full)? Do they need emptying of trapped sediment?
  - Do fences need restaking?
  - Are fences ripped, do they need replacing?
- Are additional control measures required for the catchment?
- Does the site need slashing?
- Is discharge water within release criteria?

#### **5.4 Non Conformance**

Where a non-conformance is noted either by the site supervisor (or delegate), environmental scientist, or as reported by a member of the public, actions to remedy the non-conformance may involve:

- providing additional environmental controls
- obtaining specialist advice and refining the SWMP
- reviewing site management practices or work methods, and
- providing further training to personnel and subcontractors.

Issues or matters that do not have an off-site impact do not require a non-conformance report to be completed.

An example of non-conformance would be where downstream WQ has deteriorated (in comparison to local WQ data) as a result of the discharge of sediment laden construction water from the haul road construction site. The report would state what the issue was, the effect of the incident, clean up measures (if required) and how the incident would be prevented.

In the event of a notifiable incident as pollution under the NSW Protection of Environment Operations Act 1997 (POEO Act), the NSW Environment Protection Authority (EPA) would be notified as soon as practicable and other relevant NSW regulatory agencies, together with internal departments of TSC (where relevant) within 24 hours after the occurrence of the incident.

#### **5.5 Reporting a Pollution Event**

There is a duty to report pollution incidents. Section 148 of the POEO Act states, *Pollution incidents causing or threatening material harm to the environment must be notified.*

The POEO Act defines a 'pollution incident' as:

*An incident or set of circumstances during or as a consequence of which there is or is likely to be a leak, spill or other escape or deposit of a substance, as a result of which pollution has occurred, is occurring or is likely to occur. It includes an incident or set of circumstances in which a substance has been placed or disposed of on premises, but it does not include an incident or set of circumstances involving only the emission of any noise.*

Section 147 of the POEO Act states:

(1) For the purposes of this Part:

(a) harm to the environment is material if:

(i) it involves actual or potential harm to the health or safety of human beings or to ecosystems that is not trivial, or

(ii) it results in actual or potential loss or property damage of an amount, or amounts in aggregate, exceeding \$10,000 (or such other amount as is prescribed by the regulations), and

(b) loss includes the reasonable costs and expenses that would be incurred in taking all reasonable and practicable measures to prevent, mitigate or make good harm to the environment.

(2) For the purposes of this Part, it does not matter that harm to the environment is caused only in the premises where the pollution incident occurs.

Notification must be given immediately, i.e. promptly and without delay, after the person becomes aware of the incident. Refer to Section 5.7 for Responsibility's and Contacts List for reporting purposes.

## **5.6 Review and Improvement of the SWMP**

The outcomes of inspections, monitoring, audits and the completion of checklists will identify recurring issues or areas that require improvement. Where identified, the effectiveness of the ESC measures will be reviewed and assessed for improvement as required.

This SWMP is considered as an adaptive management plan that will be updated as needed during the course of the haul road construction project. Additionally, a formal review would be undertaken annually to ensure industry best practice is continually achieved.

Annual reviews would consider items such as:

- Inspection/audit findings
- Minutes of site meetings
- Environmental monitoring records
- Details of corrective and preventative actions taken
- Environmental non-conformances
- Incident reports & non-conformance
- Changes in responsibilities and contacts
- Industry best practice

## 5.7 Responsibilities and Contacts

Contacts for the haul road project are listed in Table 10.

**Table 10: Contacts List**

<b>Position</b>	<b>Responsible Officer</b>	<b>Contact Number</b>
<b>Client TSC Waste Management</b>	Rod Dawson Manager Waste	<b>0428 864 440</b>
	Mark Longbottom	<b>0409 690 874</b>
<b>Clients nominated representative</b>	Mick Donohue (NSW Public Works)	<b>0413 458 601</b>
<b>Haul Road Site Supervisor Infrastructure Delivery</b>	Construction Engineer Robert Hanby	<b>0428 635 879</b>
	Construction Supervisors Frank Castellano	<b>0420 962 988</b>
	Scott Buckleton	<b>0447 150 677</b>
<b>TSC Environmental Scientists</b>	David Hannah	<b>0410 031 775</b>
	Greg Jones	<b>0468 410 214</b>
<b>TSC After hours</b>	Emergency after hours	<b>1800 818 326</b>
<b>Tweed Laboratory</b>	Paul Wright	<b>07 5569 3103</b>
<b>Emergency</b>	Fire/Ambulance/Police	<b>000</b>
<b>NSW EPA</b>	Pollution Line	<b>131 555</b>

## 6 REFERENCES

Ahern, C.R., Stone, Y. and Blunden, B. (1998) Acid Sulfate Soil Manual 1998. Acid Sulfate Soil Management Advisory Committee, Wollongbar, NSW, Australia

Australian and New Zealand Environment and Conservation Council (2000). Australian and New Zealand Guidelines for Fresh and Marine Water Quality 2000

Department of Infrastructure, Planning and Natural Resources (1997) Acid Sulfate Soil Planning Map (Edition 1) –Map 1:25 000.

Landcom (2004). Managing Urban Stormwater: Soil and Construction. 4th Edition. NSW Government

GHD (2010). Report for Eviron Road Quarry and Landfill Proposal. (Tweed Shire Council), Stormwater and Sediment Management.

Morand, D.T. (1996) Soil Landscapes of Murwillumbah – Tweed Heads 1:100 000 Sheet Report. Department of Land and Water Conservation, Sydney

NSW Roads and Maritime Service (2015), Guideline for Batter Surface Stabilisation using Vegetation

Tweed Shire Council Development Design Specification D7 Stormwater Quality Version 1.4

Witheridge, G., (2010).Erosion & Sediment Control: A Field Guide for Construction Site Managers. Version 2 February 2010. Catchment & Creeks Pty Ltd.

## **APPENDICES**

### **APPENDIX A - TSC Erosion and Sediment Control Design Plans**

**This Page is Blank**



**APPENDIX B – Code of Practice**

**This Page is Blank**

## ANNEXURE A

## CODE OF PRACTICE FOR SOIL AND WATER MANAGEMENT ON CONSTRUCTION WORKS

(Source: Derived from "Appendix M: Model Code Of Practice For Soil & Water Management on Urban Lands" of "Managing Urban Stormwater, Soils and Construction", Landcom 4<sup>th</sup> Edition 2004, and "Soil and Sediment Control - Engineering Guidelines for Queensland Construction Sites 1996" The Institute of Engineers, Australia, Queensland Division, and amended for Tweed Shire conditions.)

## D7.A1 General

- 1.1 Stormwater quality works in the construction phase are focused on erosion and sediment control.

The aims of erosion and sediment control are:

- (a) Minimise soil erosion and exposure
- (b) Minimise transportation of eroded soil by air and water
- (c) Limit suspended solids concentration in stormwater to not more than 50mg/l
- (d) Limit/minimise the amount of site disturbance
- (e) Isolate the site by diverting clean upstream "run on" water around the development
- (f) Control runoff and sediment at its point source rather than at one final point
- (g) Stage ground disturbance/earthworks and progressively revegetate the site where possible to reduce the area contributing sediment
- (h) Retain topsoil for revegetation works
- (i) Locate sediment control structures where they are most effective and efficient

- 1.2 The owner of land being developed is responsible for erosion and sediment control on the site and the actions of all persons (including employees, plant operators, contractors, subcontractors, delivery drivers etc) who may cause erosion and sediment generation. This also includes responsibility for erosion and sediment generation on adjacent land where construction activities or materials have encroached on the adjacent land.

- 1.3 The **primary** reference manual for erosion and sediment control works in this code of practice shall be "*Managing Urban Stormwater, Soils and Construction*" Landcom 4<sup>th</sup> Edition, 2004.

The **secondary** reference manual shall be "*Soil and Sediment Control - Engineering Guidelines for Queensland Construction Sites 1996*" The Institute of Engineers, Australia, Queensland Division. Construction works must also comply with the requirements of Tweed LEP 2000 clause 35 which regulates works (including drainage) on areas identified as having acid sulphate soils and the provisions of the "*Acid Sulphate Soil Manual, 1998 - Assmac*".

Reference numbers in brackets [Ref1..] refer to sections of the **primary** reference manual, reference numbers in brackets [Ref2..] refer to sections of the **secondary** reference manual .

## D7.A2 Preparation of ESCP

## STORMWATER QUALITY

---

### 2.1 Steps in preparation of ESCP

To prepare an ESCP the following steps are to be considered:-

- (a) Location of disturbance and non-disturbance zones, minimising extent and duration of disturbed areas
- (b) Location of fencing and signage for non-disturbance and buffer zones
- (c) Location and controls on construction entry/exit points
- (d) Location of site office, parking, stockpile and material storage areas
- (e) Determine and locate drainage and sediment controls for d)
- (f) Location temporary construction roads
- (g) Division of site into manageable drainage sectors
- (h) Staging, and programming (soil loss class constraints) of construction works for compatibility with ESCP in each drainage sector
- (i) Clean water management strategies for each drainage sector (diversion around disturbed, stockpile and risk areas)
- (j) Controls for channelised flow velocities
- (k) Erosion controls on each disturbed area
- (l) Control of sediment laden runoff
- (m) Control of sediment in surface runoff at site boundaries
- (n) Trapping of sediment within the development
- (o) Location and operation of sediment basins
- (p) Dust control measures
- (q) Revegetation program
- (r) Installation and decommissioning schedule
- (s) Maintenance and monitoring program
- (t) Assessment of effectiveness of ESCP in terms of soil loss (RUSLE) and impact on receiving waters

### 2.2 Application of Soil Loss Class

The soils on the development site shall be classified as follows

Soil Loss Class	Calculated soil loss (tonnes/ha/year As calculated by RUSLE)
1	0 to 150
2	151 to 225
3	226 to 350
4	351 to 500
5	501 to 750
6	751 to 1,500
7	>1,501

The ESCP shall use soil loss class data to ensure that works are seasonally programmed to keep soil loss below the rate of 37.5 tonnes/hectare/year in any 2-week period. The times when a regular suite of BMPs are normally adequate to keep soil loss within this range are:

Period	Soil Classes That May Be Developed
January	1 – 5
February and March	1 – 4
April and May	1 – 5
June, July, August, September October and first half November	1 – 6
Second half November and December	1 – 5

at other times the ESCP must ensure soils in these classes are revegetated or otherwise protected

2.3 ESCP plans shall use standard drawing symbols in [Ref 2, A8]

**D7.A3 Clearing Vegetation, Soil Disturbance**

- 3.1 The removal or disturbance of trees, shrubs and ground covers shall be minimised.
- 3.2 Buffer zones consisting of corridors of undisturbed vegetation adjacent to waterways or disturbed area are to be retained to reduce nutrient levels in runoff, unless these areas are protected by other means. Buffer zones are to have the following minimum widths:-

Slope %	Buffer Width in Metres
2	15
4	20
6	30
8	40
10	50
12	60
14	70

3.3 On construction/building sites:

- (a) The footpath or nature strip must not be disturbed by construction activities other than shown on the plan for:
  - (i) access to the site
  - (ii) installation of services
  - (iii) other works specifically approved by Council; and

## STORMWATER QUALITY

---

- (b) Removal and disturbance of vegetation must be confined to:
  - (i) the approved envelope area and/or permanent access ways
  - (ii) areas within 3 metres of the outermost projection of approved works and storage areas (or as required by other authorities).

Retained vegetation and buffers must be protected by a suitable fence barrier. Fenced areas shall be clearly signposted "No Access Area".

### 3.4 For subdivision work:

- (a) Clearing for works must be limited to 2 metres from the edge of any essential construction activity as shown on the engineering plans
- (b) Where practical, development must be phased, with clearing undertaken only with the development of each stage; and
- (c) Understorey ground cover vegetation may be slashed, except in areas shown on the plan, providing ground surface disturbance is minimised and a rubber tyred vehicle is used.

### 3.5 All reasonable care must be taken to protect other vegetation from damage during construction. This will involve:

- (a) Clearly marking trees to remain
- (b) Avoiding compaction of ground or filling within the drip-line of trees to be retained
- (c) Clearly delineating the area of disturbance and keeping all vehicles, building materials and refuse within that area
- (d) Limiting the number of access points to the site
- (e) Clearly restricting access to "no go" areas.

### 3.6 No vegetation is to be removed prior to approval of Council to start work on any stage, and not before the approved sediment control measures are in place.

### 3.7 Where practicable vegetative debris must be salvaged either as logs or woodchip for later reuse to control erosion or to rehabilitate the site. Non-salvageable material, such as stumps and roots, can be removed.

### 3.8 Soil disturbance activities are to be in accordance with [Ref 1] Chapter 4.2 of the manual, slope lengths on batters are not to exceed those in [Ref 1] fig 4.7 and fig 4.8.

## D7.A4 Access and Roads

### 4.1 Vehicular access must be confined to a maximum of two locations. Such locations will be shown on the ESCP and subject to the approval of Council.

### 4.2 Unless notified otherwise by Council, access for construction sites less than 1 hectare shall be fitted with a shakedown device

The shakedown device shall be either:-

- (a) a shaker grid (metal bar cattle grid minimum length 7m), placed to ensure vehicles crossing the grid have sufficient speed to shake off mud and contaminants from vehicles or

- (b) a 10m long shake down area constructed with 75mm diameter crushed rock
- 4.3 Unless notified otherwise by Council, access to construction sites of 1 hectare or more shall be fitted with a shakedown device
- The shakedown device shall be a combination of:-
- (a) a shaker grid (metal bar cattle grid minimum length 7m), placed to ensure vehicles crossing the grid have sufficient speed to shake off mud and contaminants from vehicles and
- (b) a 10m long shake down area constructed with 75mm diameter crushed rock
- 4.4 The shakedown device shall be located along the haul route, immediately before the intersection with the public road.
- Regular maintenance of shake down devices is required to ensure no material is deposited on public roads. Metal shall be cleaned/replaced when the exposed height of aggregate is less than 300mm.
- Shaker grids are required on sites where more than 1,000m<sup>3</sup> of material per month is hauled off site.
- Shakedown areas are performance based and may be subject to change or amelioration as directed by Council.
- If material is deposited on a public street, it shall be swept up and removed before the end of that working day.
- 4.5 If after using shakedown device, material is still adhering to truck wheels and being deposited on public roads, a wheel washing device must be installed and used at site exit locations to ensure no further material is carted off site and deposited on public roads.
- 4.6 Runoff from access surfaces must be drained into an adjacent sediment-trapping device before leaving the site. Where appropriate, devices to remove soil particles from vehicles must be placed at site exit locations.
- 4.7 On subdivision work, priority must be given to road and shoulder stabilisation based on erosion hazards. Where circumstances preclude the sealing of road shoulders and/or the construction of kerb and gutter, and:
- (a) where grades permit grass shoulders (less than 5%), the shoulders and associated table drains must be topsoiled and turfed, having dimensions that simplify maintenance mowing; and
- (b) where grades do not permit grass shoulders (more than 5%), the shoulders and associated table drains must be stabilised with appropriate erosion control measures (e.g. jute mesh and bitumen, cross drains, erosion matting etc.) and revegetated.
- 4.8 On subdivision work newly sealed hardstand areas must be swept thoroughly after sealing/surfacing to prevent excess aggregate or gravel entering street drains.

**D7.A5 Site Works, Erosion Control**

- 5.1 Site disturbance must not be undertaken before the issue of appropriate approvals
- 5.2 Construction sequence shall be generally in accordance with [Ref 2] A4.8.



## STORMWATER QUALITY

---

- 5.3 Schedule the construction program to minimise the potential for soil loss so that at the time from the beginning of land disturbance activities to rehabilitation is minimised.

Further on lands with a high erosion hazard:

- (a) confine land disturbance to those times of the year designated in 2.2 for each soil loss class
- (b) or show special measures on the *Plan* to address the high erosion hazard

- 5.4 Site excavation must be designed and located to minimise cut and fill.

- 5.5 Runoff and erosion controls must be installed before clearing and must include:

- (a) Diversion of upslope runoff [Ref 1, 5.4.3, 5.4.4] around cleared and/or disturbed areas or areas to be cleared and/or disturbed, providing that:
  - (i) such diverted water will not cause erosion
  - (ii) the upslope catchment area is more than 2,000 square metres
  - (iii) waters are diverted to a legal point of discharge

Diversion works are to be designed to carry peak flows at non-erosive velocities in bare soil, vegetated or lined drains/banks. Generally, the channel should be lined with turf. However, where velocities are designed in excess of 2m per second, non-erosive linings such as concrete, geotextiles, grouted rock etc or velocity reducers (check dams etc) are required.

- (b) Sediment control fences or other measures at the downslope perimeter of cleared and/or disturbed areas to prevent unwanted sediment and other debris escaping from the land; and
- (c) Maintenance of all erosion control measures at operational capacity until land is effectively rehabilitated.

- 5.6 On sites where more than 1,000 square metres are to be disturbed, runoff and erosion controls must also include:

- (a) Protection of areas to remain undisturbed through the erection of barrier fencing; and
- (b) The maximum length of exposed (disturbed) slope shall be

Max Slope length =  $90 - 48[\log(\%slope)]$  metres

% Slope	Max Slope Length (m)	% Slope	Max Slope Length (m)	% Slope	Max Slope Length (m)
1	90	10	42	19	29
2	75	11	40	20	28
3	67	12	38	25	23
4	61	13	37	30	19
5	56	14	35	35	16
6	52	15	34	40	13
7	49	16	32	45	11
8	47	17	31	50	8
9	44	18	30	60	5



- 5.7 Where possible, topsoil must be stripped only from those areas designated on the *Approved Plan*, and must be stockpiled for later use in rehabilitation and landscaping. Site topsoil shall be isolated from subsoil material in separate stockpiles.
- 5.8 Stockpiles (topsoil, spoil, subsoil, bricklayers loam, sand or other) must :
- (a) not be located on public footpaths, nature strips, roads, road shoulders or any other public land;
  - (b) be located at least 2 metres from any hazard areas, including surfaces with grades greater than 15%, zones of concentrated flow, gutters, drains, driveways, tree drip zones, swales or standing vegetation;
  - (c) be protected from upslope surface flows;
  - (d) be provided with sediment filters downslope; and
  - (e) be provided with a protective cover that reduces the C-factor [Ref 1, Appendix M] on bare surface areas to 0.15 or less where they are unlikely to be worked for more than 20 working days.
- 5.9 Fill batters should be located to avoid established trees, where this is not possible a tree surgeons advice is to be followed to minimise damage. Where retention is not possible affected trees are to be removed to reduce risk to slope stability.
- 5.10 Unless directed otherwise by approved plans and specifications, trenches must be backfilled and compacted to 95% standard compaction and capped with topsoil up to adjoining ground level and must be turfed or sown with an approved seed and fertiliser mix.
- 5.11 Excess spoil may be retained on site provided the stockpile area is prepared by stripping topsoil from beneath the fill site and respreading it later over affected areas.
- 5.12 All sedimentation control measures must be maintained at, or above their design capacity.
- 5.13 High efficiency dust control techniques must be employed on site on an as needs basis to prevent the emission of dust from the site [Ref 1 6.3.10]. Such techniques must be applied to the movement of soil, sand, all excavated areas, stockpiles, haul roads and ramps, and to any other areas or applications where the potential for dust generation exists. These control techniques may include the use of water sprays, application of dust suppressants, surface stabilisation or covering exposed surfaces. Dust control techniques must be employed on site at all times including outside normal working hours. All permanent roads and trafficable areas must be sealed or hard surfaced to minimise dust generation. Unless an exemption from Council is obtained, all sites where over 1,500 sq m are to be disturbed must be provided with a barrier fence wind break [Ref 1 6.3.6(b)(iv)].

**D7.A6 Stormwater Control**

- 6.1 When roof structures and piped or artificial stormwater systems are in place, discharge water is to be managed in a manner that reduces the likelihood of erosion. Roof water systems must be functional and discharge to the stormwater system before roof runoff begins. The stormwater system must prevent sediment from being eroded from the site and deposited downstream.

**D7.A7 Sediment Control**

- 7.1 All sediment control measures and facilities must be installed and stabilised before other site earthworks or measures are commenced including stormwater diversion facilities.

## STORMWATER QUALITY

---

- 7.2 Sediment basin(s) must be constructed where the area to be developed exceeds 1 hectare. Where it is less than 1 hectare, other sediment control devices may be accepted.
- 7.3 Silt fences, hay bales and other sediment filters. Design shall generally be in accordance with [Ref 1] Chapter 6.3.7 of the manual and manual standard drawings SD6.7 - 6.12 except as varied by the following criteria:-
- (a) Maximum flow in to the silt fence from a design ARI 3 month storm (deemed to be 40% of the ARI one year event), is not to exceed 1.6l/sec/metre (or the maximum catchment per metre of fence etc is not to exceed 45 m<sup>2</sup>), and
  - (b) The fence or structure must be structurally viable and able to support hydraulic pressures during the ARI 100 year storm.
  - (c) Maximum post spacing 2m or 3m with wire mesh backing
  - (d) In fences or structures longer than 30m, spill through weirs shall be installed at 20-30m spacing
  - (e) Spill through weirs shall consist of a rock filled wall contained between an enclosed steel mesh fence retaining wall. Weir length 1.2m, thickness 0.6m, height 0.5m. Rock shall be 25-50mm aggregate.
  - (f) Sediment is to be removed after each rainfall event and weirs are to be regularly maintained and cleaned to ensure effective operational condition.
  - (g) Straw bales and silt fence geotextiles are to be replaced when damaged or permanently blocked and fully replaced at not more than six monthly intervals.
- 7.4 Where sediment ponds are required these are to be constructed upstream of any wetponds/wetlands or receiving waters and preferably off line.
- 7.5 A marker must be placed within each sediment retention basin to show the level above which the design capacity occurs. Plans shall indicate whether basins are to be temporary or permanent.
- 7.6 Where sediment retention basins are required, they must be designed to treat the design rainfall event sediment-laden stormwater emanating from the site during land development works. They must remain in place and fully operational until removal is authorised or required by Council (usually at the end of the maintenance period). Where required as part of a permanent, public stormwater management system, basins located on public land (or land to be dedicated to the public), may be accepted for Council ownership. Where required as part of a permanent, site stormwater management system, basins located on the site must be retained, operated and maintained in perpetuity by the landowner.
- 7.7 Sedimentation Basins - Design shall generally be in accordance with [Ref 1] Chapter 6.3.3 of the manual and manual standard drawings SD6.1 - 6.4 except as varied by the following criteria
- (a) Overflow/bypasses to be designed for 100 year ARI storm. Basins are to be designed so that flows greater than the ARI 3 month storm (deemed to be 40% of the ARI one year event ) are transmitted in a manner that does not remobilise and remove existing settled sediment.
  - (b) Type C basins settling zone capacity, design storm the ARI 3 month storm (deemed to be 40% of the ARI one year event ).
  - (c) Type F/D basins settling zone capacity, that necessary to contain the 75th percentile, 5 day rain event (41.5mm)

- (d) Type C basin sediment storage zone capacity, the greater of 100% of the settling zone capacity or the average 2 month soil loss as calculated by the RUSLE.
- (e) Type F/D basins sediment storage zone capacity, the greater of 50% of the settling zone capacity or the average 2 months soil loss as calculated by the RUSLE.
- (f) Basins shall be surrounded by a man-proof fence with lockable gates.
- (g) Proprietary devices (Humeceptors etc) will only be accepted in lieu of conventional sedimentation basins where they are sized in accordance with the above criteria.

7.8 Where eroding soils contain more than 10% of dispersible fines:

- (a) All waters captured in sediment basins must be treated with an approved flocculating agent. This treatment is to ensure that discharges from such basins contain no more than 50 milligrams per litre of non filtrable residues (or as specified in Council's Stormwater Management Plan). Following settlement of soil materials, the structure must be pumped out using a floating skimmer collection device.
- (b) Sediment retention basins must be maintained at a low water level in readiness for treatment and discharge of further runoff. All sediment captured in basins must be treated and discharged within 5 days of the cessation of a rainfall event; and
- (c) A minimum stockpile of flocculating agents must be retained onsite to provide for at least three complete treatments. It must be stored in a secure undercover location.

7.9 All sediment control structures must be operated and maintained in an effective operational condition following good engineering practice. These structures must not be allowed to accumulate sediment volumes in excess of 70% sediment storage design capacity. Materials removed from sediment retention basins must be disposed of in a manner approved by Council that does not cause pollution.

7.10 All weather compacted gravel vehicular access must be provided to all wetlands, sediment basins, detention basins, trash racks and gross pollutant traps etc.

7.11 Where practical surface waters from undisturbed lands must be diverted away from pollution control equipment to prevent contamination of clean runoff.

7.12 Appropriate measures must be provided to ensure that erosion and sediment control works themselves do not cause flooding, erosion or scour.

7.13 Work adjacent to Water Bodies

Without appropriate controls, earthworks adjacent to water bodies may lead to the introduction of sediment into the water-body. Typical works include bridgeworks, road embankments, wharves/jetties, boat ramps, culverts/drains/headwalls/pits, revetment walls, utility installations, etc.

These works must be carried out in a manner that prevents sediment being transported to the adjacent water body.

Methods of controlling earthworks adjacent to water bodies include:-

## STORMWATER QUALITY

---

- (a) Using a floating sediment fence to isolate polluted waters (the sediment fence must extend from the floats on the water surface to the bed of the water body to fully contain the polluted water).
- (b) Water filled dams can be used to exclude water from the work area.
- (c) Embankments and other works can be constructed behind a barrier (e.g. water inflated dam, sheet piling) and surfaces fully restored before removal of barrier.
- (d) Water may be excluded or diverted from the site by coffer dams or other measures to enable construction in a water free environment. (This will require techniques for coffer dam (or other diversion systems) installation and removal that do not in themselves lead to production of sediment).
- (e) Bridge abutment works can be constructed behind appropriate sediment barrier and control systems.

### **D7.A8 Pollution Control**

- 8.1 Petroleum and other chemical products and must be prevented from entering the stormwater system or contaminating the soil. Impervious bunds must be constructed around all fuel, oil or chemical storage areas with an enclosed volume large enough to contain 110% of the volume held in the largest tank.
- 8.2 Adequate trade waste and litter bins must be provided onsite and serviced regularly.
- 8.3 Concrete wastes or washings from concrete mixers must not be deposited in any location where those wastes or washings can flow, or can be washed into any areas of retained vegetation or receiving waters.

### **D7.A9 External Site Requirements**

- 9.1 In some circumstances it may be necessary to locate sediment control devices or stabilising works outside the construction site.
- 9.2 Where increased stormwater run-off is likely to accelerate erosion of any downstream watercourse, the necessary remedial work shall be provided concurrently with other sediment and erosion requirements.
- 9.3 Where sediment is likely to be transported from the site, all immediate downstream drainage inlets shall have appropriate controls installed.
- 9.4 If such works require entry onto private property, written permission shall be obtained prior to the entry and commencement of such works. Documentary evidence to be submitted with the development application.
- 9.5 All disturbed areas on other property to be reinstated to original condition and to the satisfaction of the owner. All works to be complete prior to the release of the linen plan of subdivision or building certificate.

### **D7.A10 Rehabilitation and Landscaping**

- 10.1 All ground disturbed must be progressively stabilised and rehabilitated so it no longer acts as a source of sediment.
- 10.2 The C-factor [Ref 1 Appendix M] is to be reduced to less than 0.15 (e.g. greater than 50% grass cover) on all lands, stockpiles and other exposed materials scheduled to remain unattended for a duration of more than 20 working days.



- 10.3 The final rehabilitation or landscaping program is to be scheduled so that a duration of less than 20 working days will elapse from final land shaping to permanent rehabilitation.
- 10.4 All landscaping and rehabilitation must be completed before occupation or use of buildings or premises.
- 10.5 Topsoil shall be used in accordance with [Ref 1] Chapter 4.3 of the manual.
- 10.6 Revegetation shall be in accordance with [Ref 1] Chapter 7 of the manual.
- 10.7 All temporary erosion and sedimentation control works are to be removed when works are completed and revegetation is successfully established on formerly disturbed areas. All redundant materials used for temporary erosion and sedimentation control works are to be removed from the site and all affected areas reinstated.

#### D7.A11 Operation, Maintenance

- 11.1 All erosion and sediment controls must be operated in accordance with the ESCP and maintained to be fully operational at all times. Worn, damaged or otherwise defective materials and components are to be repaired, refurbished or replaced as they become ineffective for their design purpose.
- 11.2 Where more than 2,500 square metres of land are disturbed, a self auditing program must be developed for the site. A site inspection self audit and monitoring program must be undertaken by the land developer:
- (a) at least each week
  - (b) immediately before site closure
  - (c) immediately following rainfall events that cause runoff.
- 11.3 The self-audit must be undertaken systematically on site (e.g. walking anticlockwise from main entrance) and recording:
- (a) installation/removal of any erosion and sediment control device
  - (b) the condition of each device employed (particularly outlet devices), noting whether it is likely to continue in an effective condition until the next self audit
  - (c) circumstances contributing to damage to any devices, accidental or otherwise
  - (d) storage capacity available in pollution control structures, including:
    - (i) waste receptacles and portable toilets
    - (ii) trash racks
    - (iii) sediment barriers and traps
    - (iv) gross pollutant traps
    - (v) wetlands/water quality control ponds
  - (e) time, date, volume and type of any additional flocculants
  - (f) the volumes of sediment removed from sediment retention systems, where applicable, and the site where sediment is disposed
  - (g) maintenance or repair requirements (if any) for each device

## STORMWATER QUALITY

- (h) circumstances contributing to the damage to device
- (i) repairs affected on erosion and pollution control devices

11.4 Signed, completed self audits, original test results, weekly and other result sheets shall be kept on site and are to be available on request to Council officers and other relevant statutory authorities.

### D7.A12 Monitoring

12.1 Stormwater monitoring shall take place at all locations where drainage or surface water leaves the site or enters any natural or artificial receiving waters and at other locations as directed by Council or other statutory authority. Samples shall be taken and tested as follows:

Parameter	Frequency	Reporting
Suspended Solids, Non Filterable Residue (NFR)	monthly or during discharge event (defined as >25mm in any 24 hour period)	as per 11.4. Non complying test results are to be notified within 24 hours to Council officers
pH	<ul style="list-style-type: none"> <li>• if in acid sulphate soils risk area, daily or during controlled discharge event</li> <li>• in areas with no identified acid sulphate risk, monthly and during controlled discharge event from sedimentation basins</li> </ul>	as per 11.4. Non complying test results are to be notified immediately to Council's Environmental & Health Services Unit
Total P, Total N	3 monthly	as per 11.4

### D7.A13 Response to Monitoring, Non Compliance with ESCP, Amelioration Measures

13.1 Non compliance with Approved *Plans* and conditions of consent must be dealt with immediately. If there is a breach or infringement of conditions, action will be taken consistent with the nature and seriousness of the breach or infringement. Action may include:

- (a) issue of "stop work notice"
- (b) a fine under the provisions of the Protection of the Environment Operations Act 1997
- (c) notice to comply pending reinspection of the site.

13.2 Standard responses to Non Compliance

The following responses are required by the developer to non complying monitoring test results:

Indicator	Response	Comments
pH too low <6.5	<ul style="list-style-type: none"> <li>• If possible stop discharge and store runoff on site</li> <li>• Respond in accordance with approved acid sulphate management plan or if no plan then</li> <li>• lime dose as per Acid Sulphate Soil Manual (Assmac), restore to acceptable pH before further discharge</li> <li>• Notify Council's Environmental and health Services Unit of non compliant discharge (within 24 hours)</li> </ul>	Reporting as per section 12
pH too high >8.5	<ul style="list-style-type: none"> <li>• If possible stop discharge and store runoff on site</li> </ul>	

**STORMWATER QUALITY**

	<ul style="list-style-type: none"> <li>• Dilute with other water until pH in acceptable range</li> <li>• re-test for compliance before further discharge</li> </ul>	
<p>Suspended Solids (NFR) &gt;50mg/litre</p>	<p>Identify if non compliance is due to storm event greater than design storm of control devices. If so accept non compliance. If not then:-</p> <ul style="list-style-type: none"> <li>• If possible stop discharge and store runoff on site</li> <li>• Use flocculation agents to lower NFR or</li> <li>• Pump contaminated water over grassed filter strips or buffer areas to lower NFR</li> <li>• Identify (by inspection and/or analysis) if non compliance is due to damage of ineffectiveness of erosion and sediment control devices. Repair or redesign/replace if necessary (or required by Council) to ensure future compliance.</li> </ul>	<p>Non compliance may occur, by design, in &gt; 3month (deemed to be 40% of the ARI one year event)</p>

## **APPENDIX C - Standard Drawings and Examples**

Standard Drawings have been sourced from the Blue Book (Landcom, 2004)

All other photos and images are from Field Guide for Construction Managers (Witheridge, 2010)



## Sediment Fence SD6-8

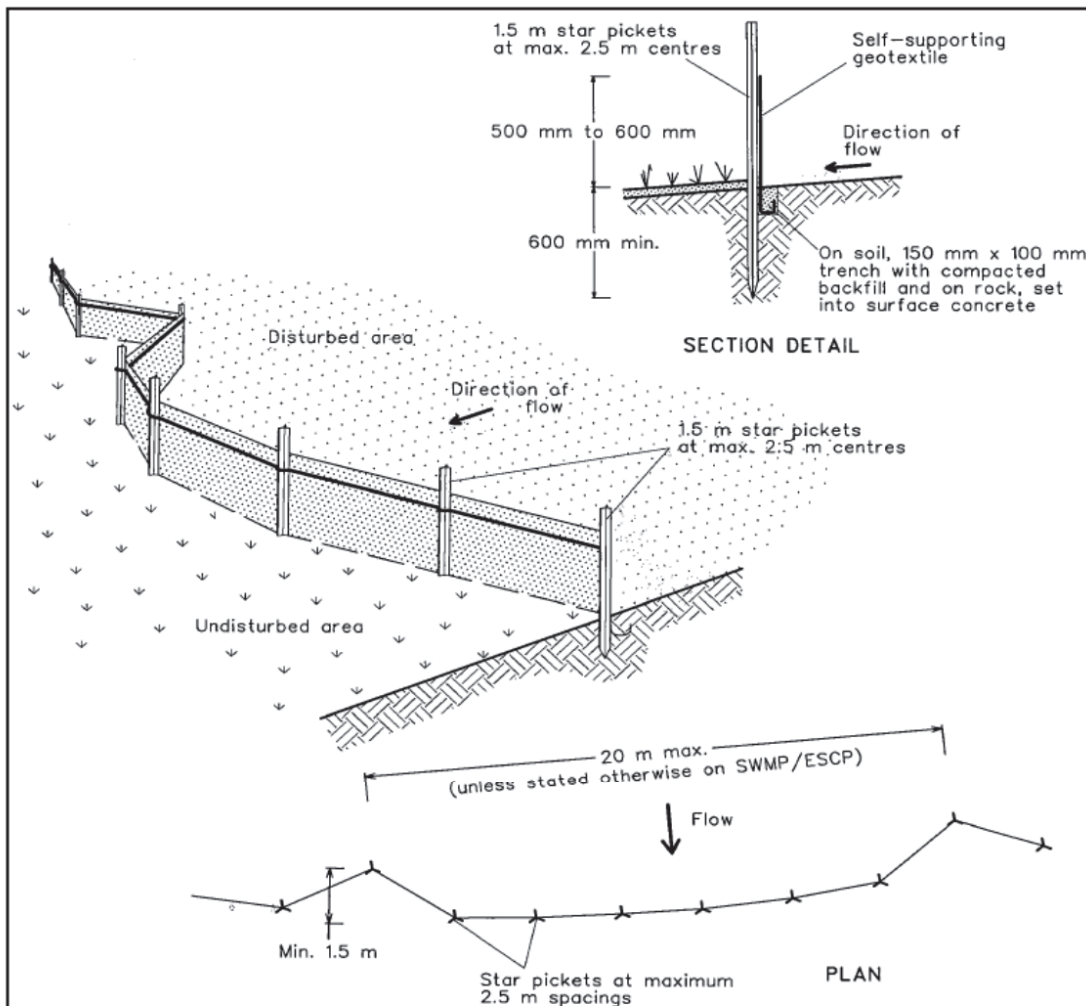

### Construction Notes

1. Construct sediment fences as close as possible to being parallel to the contours of the site, but with small returns as shown in the drawing to limit the catchment area of any one section. The catchment area should be small enough to limit water flow if concentrated at one point to 50 litres per second in the design storm event, usually the 10-year event.
2. Cut a 150-mm deep trench along the upslope line of the fence for the bottom of the fabric to be entrenched.
3. Drive 1.5 metre long star pickets into ground at 2.5 metre intervals (max) at the downslope edge of the trench. Ensure any star pickets are fitted with safety caps.
4. Fix self-supporting geotextile to the upslope side of the posts ensuring it goes to the base of the trench. Fix the geotextile with wire ties or as recommended by the manufacturer. Only use geotextile specifically produced for sediment fencing. The use of shade cloth for this purpose is not satisfactory.
5. Join sections of fabric at a support post with a 150-mm overlap.
6. Backfill the trench over the base of the fabric and compact it thoroughly over the geotextile.

**SEDIMENT FENCE**

**SD 6-8**

## Earth Bank Low Flow SD5-5

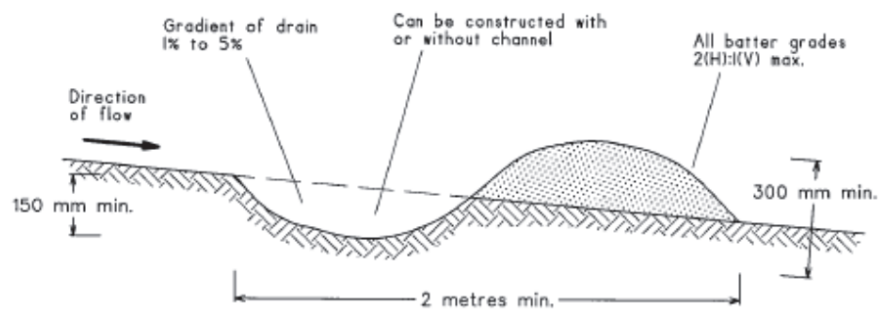

NOTE: Only to be used as temporary bank where maximum upslope length is 80 metres.

### Construction Notes

1. Build with gradients between 1 percent and 5 percent.
2. Avoid removing trees and shrubs if possible - work around them.
3. Ensure the structures are free of projections or other irregularities that could impede water flow.
4. Build the drains with circular, parabolic or trapezoidal cross sections, not V shaped.
5. Ensure the banks are properly compacted to prevent failure.
6. Complete permanent or temporary stabilisation within 10 days of construction.

**EARTH BANK (LOW FLOW)**

**SD 5-5**

**Level Spreader SD5-6**

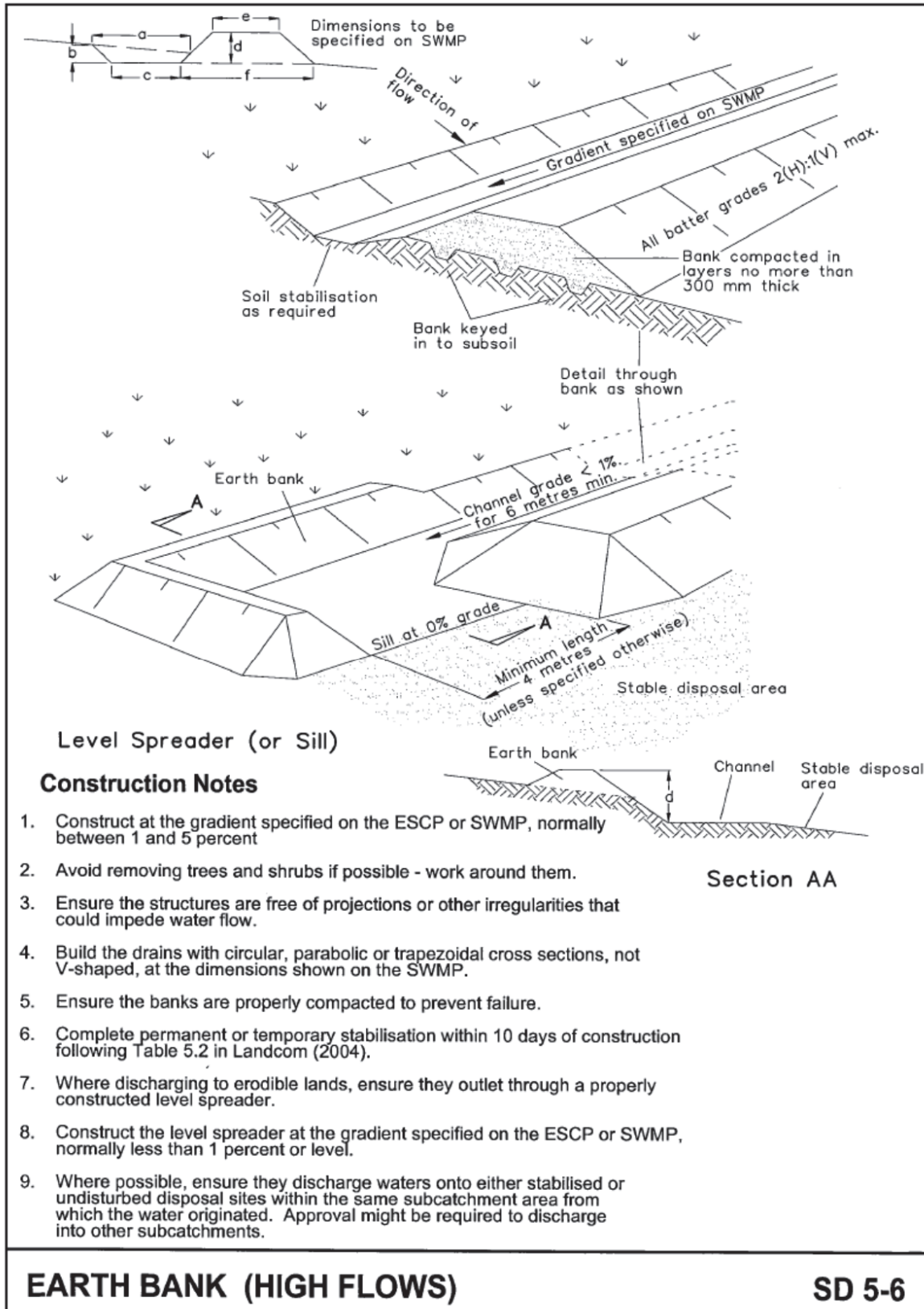

## Stock Piles SD4-1

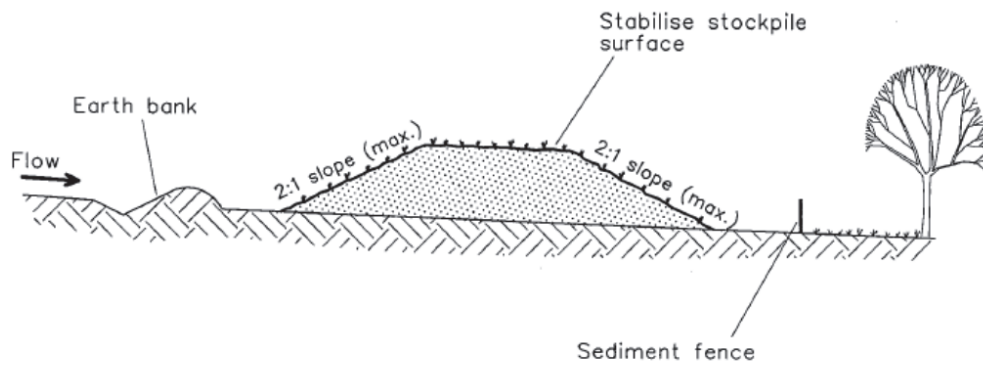

### Construction Notes

1. Place stockpiles more than 2 (preferably 5) metres from existing vegetation, concentrated water flow, roads and hazard areas.
2. Construct on the contour as low, flat, elongated mounds.
3. Where there is sufficient area, topsoil stockpiles shall be less than 2 metres in height.
4. Where they are to be in place for more than 10 days, stabilise following the approved ESCP or SWMP to reduce the C-factor to less than 0.10.
5. Construct earth banks (Standard Drawing 5-5) on the upslope side to divert water around stockpiles and sediment fences (Standard Drawing 6-8) 1 to 2 metres downslope.

**STOCKPILES**

**SD 4-1**

## Stabilised Access SD6-14

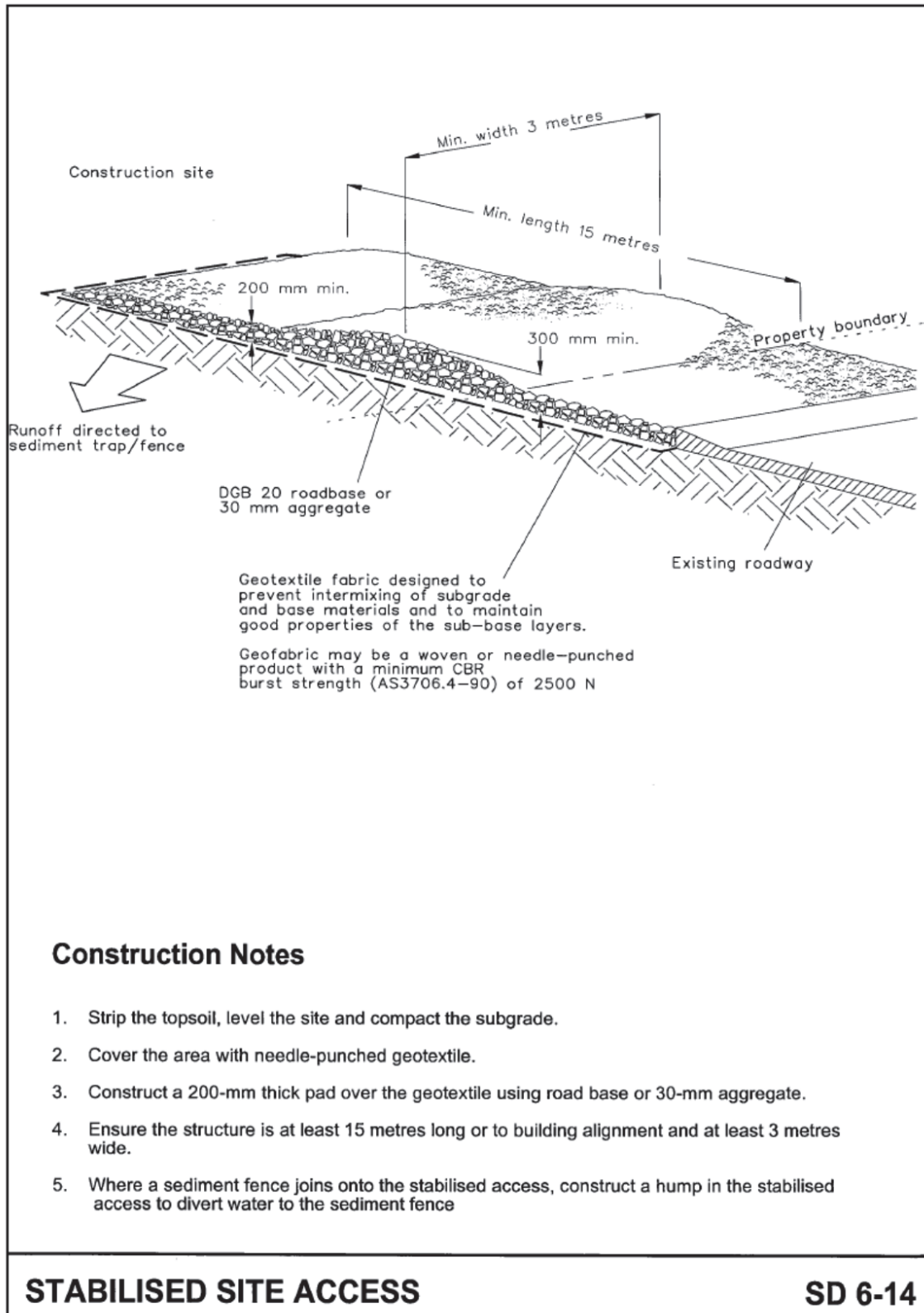



## Typical Site Entry and Exist Controls

### Entry/exit sediment controls (Exit)



Rock pad



Vibration grid

- Suitable for all soil types.
- The critical design parameter is the total void spacing between the rocks.
- Minimum 10m length for single dwelling building sites, and 15m for construction sites.
- Generally perform better than *Vibration Grids* during wet weather.
- Drainage controls (e.g. cross bank) may need to be incorporated into the rock pad to direct sediment-laden runoff to an appropriate sediment trap.

- Vibration grids are best suited to sandy soils.
- Can also be used in clayey soil regions to control sediment movement from heavy construction traffic during dry weather.
- A rock pad must extend from the vibration grid to the sealed road surface.



Site signage

- It is important to ensure trucks and other construction equipment leaving the site do not transport sediment or rocks onto public roads.
- Rock of a size 75 to 100mm can become wedged between dual tyres and transported off the site.
- Where appropriate, place signs to remind drivers to check their loads, tie ropes, and covers.

### Check Dams SD5-4

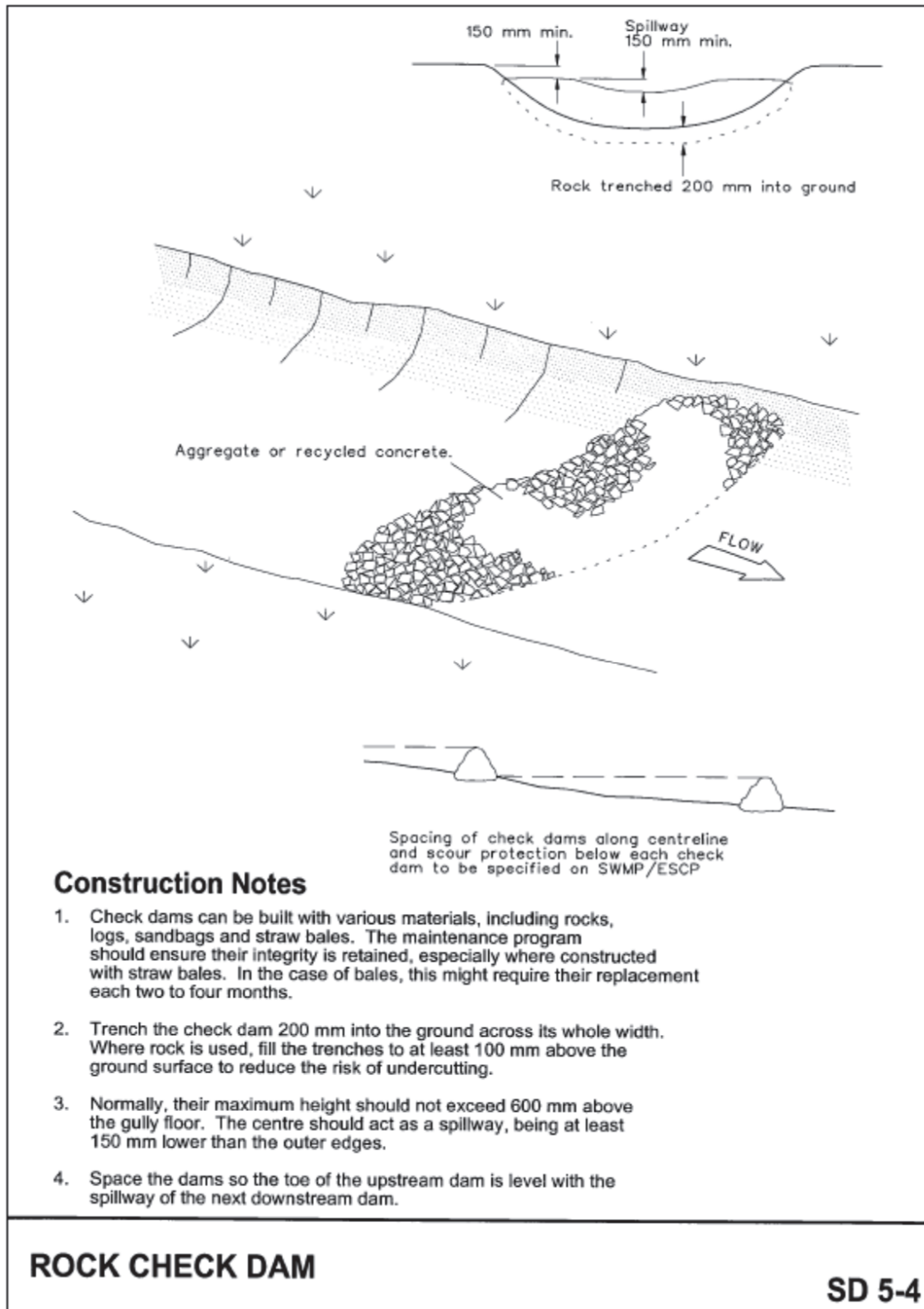

#### Construction Notes

1. Check dams can be built with various materials, including rocks, logs, sandbags and straw bales. The maintenance program should ensure their integrity is retained, especially where constructed with straw bales. In the case of bales, this might require their replacement each two to four months.
2. Trench the check dam 200 mm into the ground across its whole width. Where rock is used, fill the trenches to at least 100 mm above the ground surface to reduce the risk of undercutting.
3. Normally, their maximum height should not exceed 600 mm above the gully floor. The centre should act as a spillway, being at least 150 mm lower than the outer edges.
4. Space the dams so the toe of the upstream dam is level with the spillway of the next downstream dam.

**ROCK CHECK DAM**

**SD 5-4**



## Typical check Dams

Eg sandbags, rock check dams, hay bales etc

 <p>Photo supplied by Cairnments &amp; Cousins Pty Ltd</p>	<ul style="list-style-type: none"><li>• Sandbag check dams are typically used in drains less than 500mm deep, with a gradient less than 10%.</li><li>• These check dams are typically small (in height) and therefore less likely to divert water out of the drain compared to rock check dams.</li><li>• Sandbag check dams can also be used as a temporary (supplementary) sediment trap.</li></ul>
<p><b>Sandbag check dam (SBC)</b></p>  <p>Photo supplied by Cairnments &amp; Cousins Pty Ltd</p>	<ul style="list-style-type: none"><li>• Rock check dams should only be used in drains at least 500mm deep, with a gradient less than 10%.</li><li>• They should only be used in locations where it is known that they will be removed once a suitable grass cover has been established within the drain.</li><li>• Can also act as minor sediment traps.</li><li>• Rock check dams can be used as a permanent velocity-control device and/or sediment trap in non-vegetated, earth-lined drains (check with road authority).</li></ul>

## Windrows at top of batter





### Batter Chutes and Dissipater's

Batter drop down chutes would be progressively staged to account for increase in fill, elevation and slope as it progresses to final design RL. Drop down chutes would evolve from a temporary structure for concentrated flows to a permanent structure at completion of works.

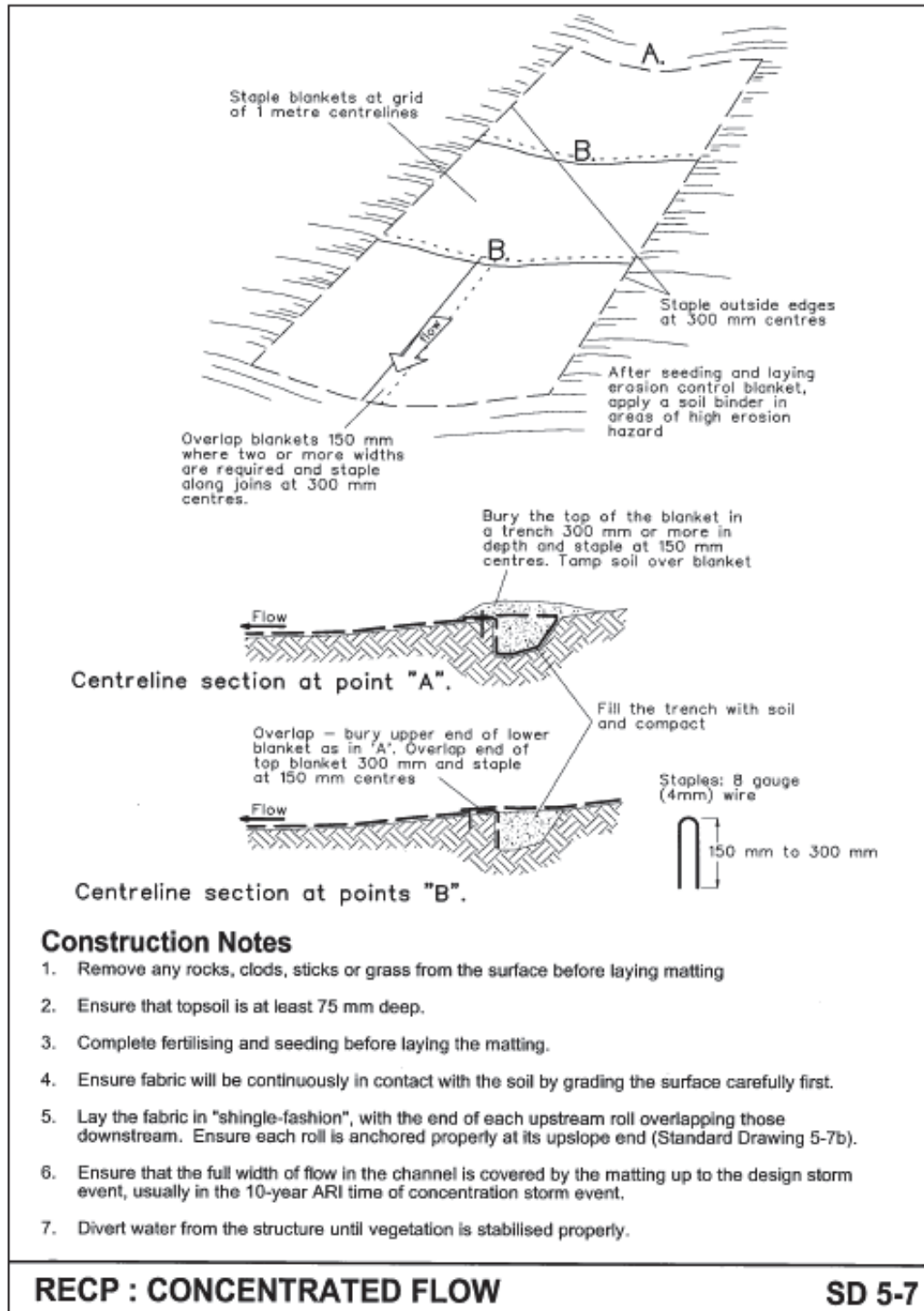

## Permanent and Temporary Chutes



Photo 1 – Permanent, grouted-stone batter chute



Photo 2 – Temporary batter chute lined with filter cloth

### Key Principles

1. The critical design components of a chute are the flow entry into the chute, the maximum allowable flow velocity down the face of the chute, and the dissipation of energy at the base of the chute.
2. The critical operational issues are ensuring unrestricted flow entry into the chute, ensuring flow does not undermine or spill out of the chute, and ensuring soil erosion is controlled at the base of the chute.
3. Most chutes fail as a result of water failing to enter the chutes properly. It is critical to control potential leaks and flow bypassing, especially at the chute entrance.

### Design Information

*The material contained within this fact sheet has been supplied for use by persons experienced in hydraulic design.*

Drainage chutes are hydraulic structures that need to be designed for a specified design storm using standard hydrologic and hydraulic equations. The hydraulic design can be broken down into three components:

- **Inlet design:** flow conditions may be determined using an appropriate weir equation. It is important to ensure that the water level upstream of the chute's inlet will be fully contained by the associated *Flow Diversion Banks*.
- **Chute lining:** selection of an appropriate chute lining is governed by the estimated flow velocity, which can be determined on long chutes through use of **Manning's equation**.
- **Outlet design:** a suitable energy dissipater or outlet structure is required at the base of the chute. The design of these structures is usually based on the use of standard design charts.



### Temporary Chutes



Temporary Batter chute



Clean water diversion drain or chute

## APPENDIX D - Sediment Basin Designs

Sediment basin design and sizing has been undertaken in-line with the detailed calculation spreadsheets of Appendix J of the Blue Book (Landcom 2004).

The “Detailed Calculation” spreadsheets relate only to high erosion hazard lands where the designer chooses to use the RUSLE to size sediment basins.

The Revised Universal Soil Loss Equation or RUSLE is presented below (equation 1). Adopted values used for design calculations are listed below in Table D1 (as presented earlier in Section 2.3 Table 3). Copies of the detailed calculation spreadsheets for all sediment basins are attached.

Volumes of proposed sediment basins are listed below in Tables D2 and D3 that relate to individual catchments that are sub catchments of the entire haul road. Refer to SD6-4 for a Type D sediment basin.

$$A = R K L S P C \dots\dots\dots \text{Equation (1)}$$

- where, A = computed soil loss (tonnes/ha/yr)<sup>[1]</sup>  
 R = rainfall erosivity factor  
 K = soil erodibility factor  
 LS = slope length/gradient factor  
 P = erosion control practice factor  
 C = ground cover and management factor.

**Table D1: Adopted design values for sediment basin calculations**

PARAMETER	FIELD CONDITION OR VALUE
Rainfall erosivity	7200 (based on R Factor maps – App B, Blue Book) 5840 as calculated from Rainfall Data (see sediment basin calculations in App.D)
Rainfall Zone	Zone 1 (Figure 4.9 Rainfall Distribution Zones, Blue Book)
Area of Disturbance	Approx. 2 ha for the haul road corridor that includes both road pavement and batters.
Slope gradients	Haul Road: Long sections of roads < 10%. Batters: up to 66%, an equivalent grade of 1:1.5.

PARAMETER	FIELD CONDITION OR VALUE
Slope lengths	Road: < 80m. Batters: typically 4 to 6m.
Slope Length/gradient factor (LS)	Road: slope length of <80m, gradient <10% = factor of 2.81. Batters: slope length of <6m, gradient <66% = factor of 3.33. Determined from Table A1 App. A of Blue Book.
Soil Erodibility (K Factor)	<p>Variable dependant on characteristics of imported soils eg low to high. Morand (1996) lists K factors of soils within the Tweed as ranging from approx. 0.01 for Type C or coarse soils, to &gt;0.09 for Type D or dispersible soils.</p> <p>In the absence of site-specific data the adopted K factor for the project site is, 0.055.</p> <p>Although this value is not considered a worst case scenario it is considered as representative of material that may be imported to site. Where operational projects would provide high volumes of suitable road building material, sediment basins would be recalculated based on site specific soil characteristics/data that may increase or decrease the annual soil loss value for the specific section (catchment), or length of haul road and its dedicated sediment basin.</p> <p>Where feasible the sediment basin design and volume may be reduced or increased dependent on the K factor of the imported material.</p>
Erosion Control Practice factor (P)	Default value of 1.3 for smooth and compact soil surface.  Determined from Table A2, App. A of Blue Book.
Ground Cover Management Factor	Default value of 1.0 for soils recently stripped of vegetation ie no cover  Determined from Figure A5, App. A of Blue Book.
Calculated soil loss	Estimated soil loss for total area of disturbance.  An estimated worst case was calculated for soil loss based on: <ul style="list-style-type: none"> <li>• an approx. road pavement area of one hectare with a maximum slope of 10%, and a maximum slope length of &lt;80m</li> <li>• an approx. batter area of one hectare with a maximum slope of 66%, and a maximum slope length of 6m.</li> </ul>

PARAMETER	FIELD CONDITION OR VALUE
	<p>The combined total soil loss was calculated at 1936 cubic metres/ha/year.</p> <p>Soil loss values that are &gt; 1500 tonnes/ha/year are rated as soil loss class 7, and considered an extremely high erosion hazard.</p> <p>Control measures will ensure that the soil loss class is less than &lt; 1500 cubic metres/ha/year which is equivalent to a Class 6 or very high erosion hazard</p>
Potential Erosion Hazard	<p>Road: very high to extremely high</p> <p>Batters: &gt; extremely high</p> <p>Controls would be installed to ensure the maximum hazard rating is very high.</p>
Volumetric Runoff Coefficient (Cv)	<p>In determination of sediment basins a Cv value of 0.58 for a soil hydrological group C and a design rainfall depth of 41-50mm.</p> <p>Determined from Table F2, Appendix F of Blue Book.</p>
Are sediment Basins required?	<p>As the calculated soil loss exceeds 150 tonnes/ha/year for the subject site sediment basins will be required.</p> <p>Where soils of more than one type are present within a specific catchment along the haul road corridor, sediment basins would be designed to meet the most stringent criterion applicable.</p> <p>For the purpose of the haul road, Type D basins will be constructed to manage potential dispersible soils imported to the site.</p>

The haul road alignment (catchment) has been split into three areas being the road surface, and the batter on each side of the elevated road. The catchment areas generally comprise the road surface and western batter forming the western basin catchment, with the eastern batter forming the eastern basin catchment.

Catchment divides or watersheds for each individual basin have generally been located at the same chainage for both western and eastern catchment's, however some catchments have been further reduced to smaller sub catchments to reduce the size of individual sediment basins. As an example the west catchment 1 (ch.810 to 1010) has 2 sediment basins, with east catchment 1 (ch. 810 to ch. 1010) split into 3 sediment basins. Refer to design plans for catchment locations.

**Table D2: Western Basin Calculated Volumes**

<b>Basin</b>	<b>Chainage</b>	<b>Total Volume</b>
W1A	910 to 1010	76
W1B	810 to 910	76
W2	725 to 810	59
W3A	640 to 725	48
W3B	600 to 640	23
W4	470 to 600	23
W5	380 to 470	52
W6	310 to 380	44
W7	230 to 310	42
W8	130 to 230	71
W9	85 to 130	33
W10	10 to 85	42

**Table D3: Eastern Basin Calculated Volumes**

<b>Basin</b>	<b>Chainage</b>	<b>Total Volume</b>
E1A	970 to 1010	13
E1B	840 to 970	58
E1C	810 to 840	14
E2	725 to 810	18
E3	600 to 725	30
E4	470 to 600	30
E5	380 to 470	20
E6	310 to 380	16
E7	230 to 310	42
E8	130 to 230	25
E9	130 to 85	13
E10	85 to 10	8

Detailed spreadsheets for Individual basin sizing and Intensity Frequency Design or IFD chart are on file and can be provided on request.



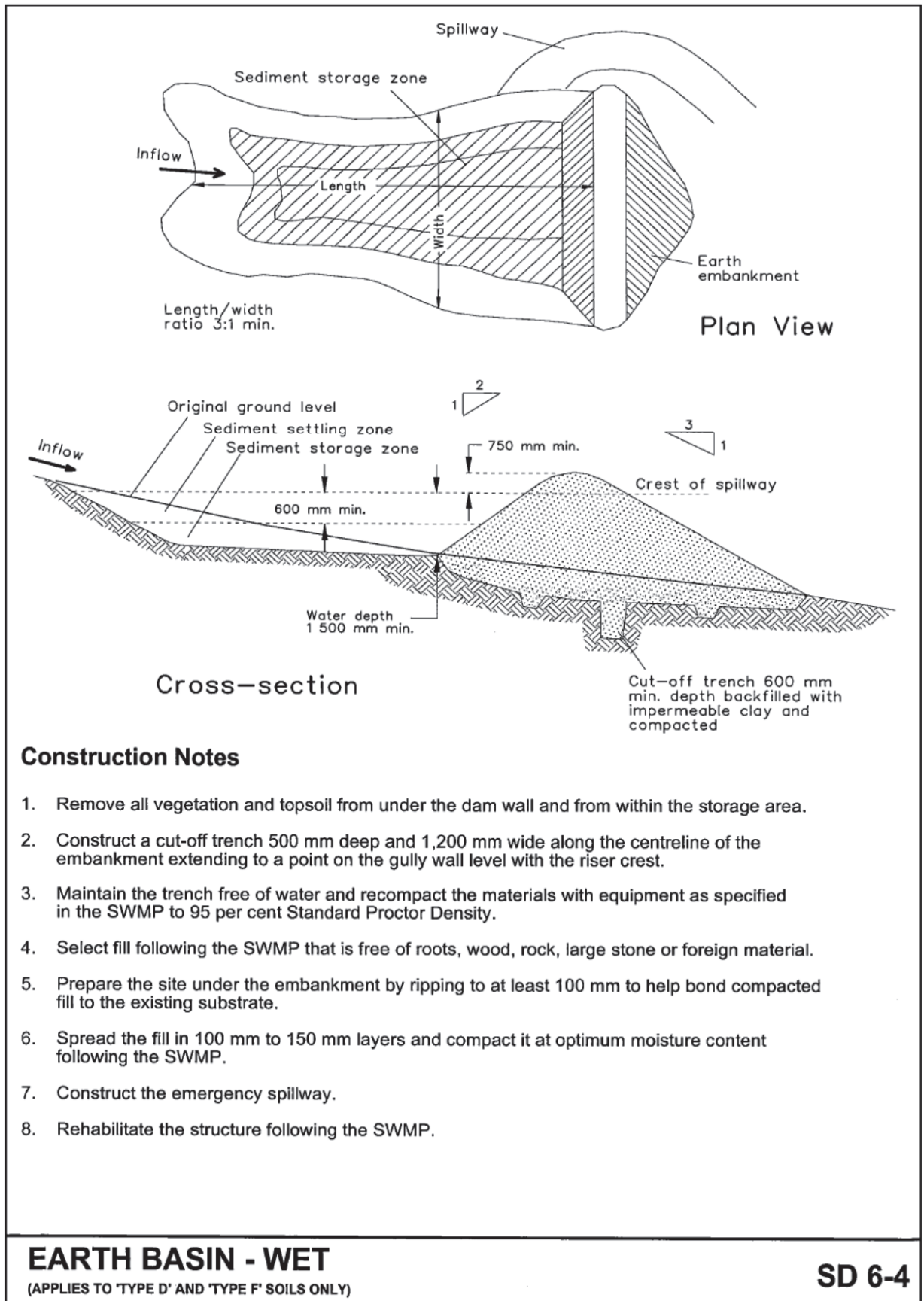



## **APPENDIX E - Sediment Basin Water Management**

### **Operations**

To manage the water quality of construction stormwater it is usually not feasible to rely solely on gravitational settlement of fine clay particles, especially if the soils are dispersive. Type F (fine material) and Type D (dispersible material) basins are designed to trap and treat a specified volume of stormwater runoff while allowing excess water to pass through the basin and over the spillway. For the purpose of this SWMP for the Haul Road project excess water is (defined) where the storm event is greater than the 5 day 80 percentile event which for Tweed Heads is 48.5mm.

The primary design parameter for Type F and Type D basins is the pond soil/sediment settling volume. Where possible the minimum calculated soil/sediment settling volume should be increased where construction space is available, however the depth of the pond should be designed to be shallow rather than deep. A shallow sediment basin will reduce the settling time of fines especially where floccing of dispersed clay fines is required.

The sediment basin walls, embankment and discharge or outlet system on a Type F and Type D basin would be designed and constructed such that the 5 day, 80 percentile event is contained within the basin to undergo settling of fines (treatment). Management of the sediment basin would ensure that treated construction water has drained or been pumped down prior to the next rainfall event.

If a pump is used to draw down construction stormwater, pumping would cease prior to settled sediments being drawn into the intake pipe. This can be achieved by use of a floating intake pipe.

### **Removal of Sediment**

Each sediment basin would have a marker peg installed within the basin to clearly identify upper limit or maximum sediment storage level. When the basin has reached the maximum storage level sediment would be extracted from the basin (when empty of construction water) and be suitably disposed of in sediment dumps, or mixed with on-site soils in a manner that will not result in unnecessary soil erosion or sediment runoff from the site, eg within the imported material for the construction of the haul road.

### **Sediment flocculation**

Where dispersible fines will not settle out by gravity a floccing agent would be required to treat construction water to a level in in-line with the adopted WQ criteria prior to release. A variety of floccing agents are available, including gypsum (hydrated calcium sulphate), and polyelectrolytes, (eg floc blocks).

Gypsum has traditionally been applied to captured stormwater runoff and is typically applied within 24 hours of the conclusion of each storm event. Products such as gypsum would be mixed into slurry and then sprayed (pumped) over the pond surface. For favourable results it is essential that the floccing agent is spread evenly over the entire pond surface.

### **Application Rates**

Care should be taken with the choice off floccing agent, prescribed dosing rates, and any manufacturer’s instructions. Overdosing or improper use may cause or contribute to offsite pollution or damage to the local ecology. The pH of receiving waters shall be assessed prior to the determination of floccing agent to mitigate offsite or downstream impacts.

Application rates of individual products will vary from soil to soil and the pH of the construction water. As soils are expected to vary from location to location along the haul road, dosing rates would likely also vary from sediment basin to sediment basin.

Additional information on dosing rates is attached from Appendix E (Settlement of Dispersed Fines) of the Blue Book (Landcom, 2004).

## E Settlement of Dispersed Fines

### E1 The Problem

Dispersible soils are those where the clay and fine silt particles (<0.005 mm) disperse into a state of separation into extremely fine colloidal units when exposed to water. These particles can remain suspended in water essentially forever because of common electrical charges on the colloidal surfaces, causing them to repel each other and stay in suspension. Stormwater runoff from exposed dispersible soils typically contains high levels of suspended solids (>500-1,000 mg/L) and turbidity. The failure of dispersed clays to settle is commonly exacerbated by wind-generated turbulence within sediment retention basins.

Settlement of these suspended particles typically requires the application of a chemical agent, which neutralises the surface charges, allowing the particles to settle relatively quickly. This process occurs naturally in estuaries, where fresh water inflows are exposed to a saline environment. This Appendix provides guidance on how chemical agents can be used to reduce the levels of suspended solids and turbidity in stormwater captured by sediment retention basins to an acceptable level, prior to discharge to the environment.

Information about dispersibility in soils at each land disturbance site should be provided in the *SWMP* along with a statement about how it will be managed. For many areas in New South Wales, information on dispersibility can be taken from Tables at Appendix C, together with the 1:100 000 soil landscape mapping available from the Department of Infrastructure Planning and Natural Resources. Information on techniques for managing the dispersible fines is given below.

### E2 A Quick Field Test

Where sites might have dispersible soils and confirmation is necessary, a simple procedure that can eliminate the need for laboratory analysis is the “field” Emerson test, a test based on the Emerson Aggregate Test (Emerson, 1967). Here, a sample of soil material is taken from the likely sediment source and worked up as a bolus.<sup>[1]</sup>

1. A sample of soil is taken that can comfortably fit into the palm of the hand, but ensure first that hands are clean (particularly, free of grease or oil). Water is added very slowly and the sample kneaded until all structure is broken down and the ball of soil just fails to stick to the fingers (it might help to crush the soil structure first with a pestle and mortar and pass it through a 2 mm sieve to remove any gravel or coarser materials). More water or soil can be added to attain this condition that is called the “sticky point”, and approximates field capacity for that soil. Continue kneading and moistening until there are no further apparent changes in the soil ball, usually about two or three minutes. The soil ball so formed is called a “bolus”. Note: that some soils:

- (i) feel sticky as soon as water is added, but lose the condition as the bolus is formed – or at least until sticky point is reached;
- (ii) are far stickier than others; and are very much harder to knead than others, e.g. heavy clays.

---

Next, a 5 to 10-mm cube of the bolus material is placed gently in a clear glass container containing sufficient distilled water to cover it. It is left to stand undisturbed for about three minutes with any change in condition noted.

One of two results is likely:

- no change will occur
- the sample will slake and/or disperse.<sup>[2]</sup>

If there is no change or the sample slakes, the sample is not dispersible and further laboratory testing should not be necessary. However, if any of the bolus disperses and goes into suspension (the water near the sample becomes milky), undertake laboratory testing to find out whether more than 10 percent of the soil material is dispersible. Note that the more material that goes into suspension, the more dispersible is that sample. Regular sediment trapping devices are ineffective with soils having more than 10 percent dispersible materials and require artificial methods to help in the settling process or enhance filtration.

## E3 Management of Dispersible Fines

### E3.1 The Process

Two broad processes can be considered to help reduce suspended solids loads where a significant proportion of these are dispersible fines: coagulation and flocculation. Coagulating agents destabilise colloidal suspensions by neutralising the surface charges allowing settlement; flocculating agents cause the colloidal particles to clump into larger units or “flocs” that can either settle in a reasonable time or be filtered.

Users of flocculating and coagulating agents should also be aware that soils can be dispersible because of either common positive or common negative charges on the colloid surfaces. Users of these agents can start from the premise that, in New South Wales, most colloid surfaces are negatively charged. However, this might not be the case at any particular site.

### E3.2 Common Agents

Many agents exist, including gypsum, alum, ferric chloride, ferric sulfate, polyelectrolytes (long-chain natural and synthetic organic polymers) including polyacrylamides (PAMS) and common salt (sodium chloride) or brine. Gypsum, PAMS and alum have traditionally been applied to treat stormwater runoff in New South Wales.

---

2. Soils that disperse must be distinguished from those that slake. Aggregates of soils that slake break down in water, but do not go into suspension as do dispersible soils, i.e. the particles settle relatively quickly.

When choosing a settling agent, note that:

- (i) the trivalent aluminium ( $\text{Al}^{3+}$ ) ion present in alum is 2,000 times more effective than the monovalent sodium ( $\text{Na}^+$ ) ion present in salt; and
- (ii) the bivalent calcium ( $\text{Ca}^{2+}$ ) ion present in gypsum is only 50 times more effective than sodium (Barnes, 1981).

As such, alum produces a much faster settling rate than gypsum (Goldrick, 1996).

### E3.3 Application Rates

Except where discussed at Section E4, below, always apply proprietary settling agents following the manufacturer's instructions as a first premise. Despite this, all sediment basins should be analysed after the first two storm events to determine the actual settling agent application rate and the settling time required. This requirement is because most soils respond differently to any particular settling agent. Standard jar tests are the usual method, undertaken following procedures set by suitably qualified laboratories.

In some situations, preliminary testing of water samples in a laboratory before discharge might be necessary to prove that the suspended solid content is below recommended levels, e.g. where the receiving waters are particularly sensitive. Naturally, all measures and procedures should be mindful of statutory requirements not to pollute waters with sediment or the agent, or from any secondary effects. In these cases, sampling details should be clearly set out in the *SWMP*.

The final application rate should be sufficiently high to permit removal of suspended solids and discharge of treated waters within an acceptable time without polluting waters with the agent itself. A rough field test that approximates an acceptable suspended solids content of 50 milligrams per litre is to fill a clear plastic or glass 65 mm diameter soft drink bottle with the water and hold it up to the light. If seeing very clearly through the sample is not possible, it is probably above 50 milligrams per litre and needs further treatment. Note, though, that materials other than suspended solids can cause water to be discoloured and laboratory testing might be necessary anyway.

### E3.4 Some Warnings

Care should be taken with the choice of an agent, its dosing rate and any special conditions to ensure that toxic situations are not created with consequent damage to the ecology – some flocculating agents can become toxic if these matters are not given due consideration. Some, such as alum, have resulted in extensive destruction to large tracts of ecosystems in the United States when not managed properly.

---

Many New South Wales waters are acidic ( $\text{pH} < 7.0$ ) and some are quite so ( $\text{pH} < 5.5$ ).<sup>[3]</sup> The ionic form of aluminium, which is highly toxic, is likely to occur below about pH 5.0 and more likely to occur at even lower pH levels. With the use of aluminium-based settling agents, accurate measurement and treatment of water pH must be undertaken to ensure that values are above 5.5 always. Regular ongoing testing of the runoff water should be undertaken to ensure that the recent exposure of certain soils in the catchment area has not caused pH levels to drop to less than 5.5. Further, any residual concentrations of alum remaining in the supernatant before discharge should not exceed the ANZECC (2000) freshwater quality “trigger value” of 0.055 milligrams per litre for aluminium at pH levels above 6.5.<sup>[4]</sup>

As for residual polyelectrolytes, ANZECC (2000) suggests that a program of field testing for them cannot be justified because they cannot be measured reliably. They do not bioaccumulate, are highly biodegradable, and do not persist in the environment. Furthermore, the guidelines state that trigger levels for polyelectrolytes have not been established yet. The Responsible Care® Guidelines for Use of Polyelectrolytes are a Code of Practice for their use. When these guidelines are followed, PACIA (1998) suggest that they have very low mammalian toxicities and, generally, are considered to be innocuous materials. Nevertheless, excessive dosing with polyelectrolytes has been shown to:

- result in the release of materials that can kill fish and other aquatic life, especially when in the cationic form
- reduce the effectiveness of the agent.

Care should therefore be exercised in the use of these chemicals in stormwater treatment.

Finally, it is important that an individual on site is charged with the responsibility of overseeing the operations and maintenance of any sediment settling systems. Detailed monitoring and maintenance records should be kept detailing rainfall on site, the

- 
3. Soil pH is a measure of the acidity or alkalinity of a soil. It relates to the concentration of the hydrogen ions ( $\text{H}^+$ ) in the soil solution measured on a negative logarithmic scale of 1 to 14. The concentrations of hydrogen ions are equal to the hydroxyl ions ( $\text{OH}^-$ ) at pH 7, greater below pH 7 (acid) and fewer above (alkaline). In the urban environment, the importance of pH is usually confined to its effect on the availability of elements in the soil and, therefore, possible deficiencies and/or toxicities. Whether these elements are available to plants depends on their solubilities, being available only when in soluble forms. The “essential” plant nutrients are in their most soluble forms around pH 6 to 7.
  4. The precipitation reaction that takes place in sediment basins can rapidly reduce the concentrations of alum in the water. Research on the leaching characteristics of alum sludge suggests that the alum is tightly bound to the sediment under both oxidising and reducing conditions at pH ranges between 5 and 7 (Metcalf, 2001). Sufficiently acid water conditions to loosen these bonds are unlikely to occur naturally in New South Wales except near poorly managed acid sulfate soils. Furthermore, pH reduction is unlikely to be induced by the use of aluminium agents themselves. Where aluminium settling agents are used properly, the sediment containing the settling agent is not considered toxic as the aluminium is bound up with the soil particles. It is common practice for the accumulated sediment to be dried on site and incorporated into fills. It should not be placed in a manner where runoff from this material can enter surface water directly.



catchment area(s) being served by the settling system(s), the degree of stabilisation, the volumes of settling agents used, and any other relevant matters.

## E4 Two Suggested Methodologies

Two possible approaches to flocculation of sediment-laden stormwater within sediment retention basins are described in the following sections. These approaches differ markedly, from the manual dosing of captured stormwater following the cessation of a storm event (i.e. batch treatment'), through to "real-time" dosing of stormwater during the storm event, typically using some automated dosing system. Manual dosing, such as the most common application of gypsum to sediment basins following storm events, is simple but time- and labour intensive, whereas an automated system is more complex in terms of design and installation, but less intensive in terms of ongoing operation (although still requiring periodic monitoring and maintenance). Consequently, this latter approach may be most suitable for long-term disturbances, where the set-up requirements are most warranted.

The following sections describe these two approaches to the flocculation of sediment basins, comprising the manual dosing of basins using gypsum, and the automated dosing of stormwater using polyaluminium chloride (PAC). Of course, other types of flocculants can be used with either of these approaches, and other methods of dosing may be used. In all cases, managers should ensure that chemical treatment of stormwater is undertaken in a way that ensures that no harmful residual levels of the chemical agent are discharged to the receiving environment while still ensuring the desired degree of settlement.

### E4.1 Manual Dosing of Basins Using Gypsum

Gypsum (calcium sulfate) is a relatively insoluble settling agent. Consequently, spreading it very evenly over the entire pond surface is essential for proper treatment of sediment-laden water. Normally, gypsum should be applied at a rate of about 30 kilograms per 100 cubic metres of stored water.

Figure E1 shows a suggested method of gypsum application for larger ponds where spreading evenly by hand is impractical. Ideally, the drum shown in figure E1 should have about a 50 litre capacity and holes about 25-mm diameter drilled on a 150-mm grid so pond water can enter. Constant stirring is necessary with the resultant slurry picked up through the inlet to a pump and sprayed evenly over the pond surface. In some instances, much higher rates of application than 30 kilograms per 100 cubic metres are necessary to achieve an acceptable suspended solids concentration, typically less than 50 milligrams per litre. Rates of up to 100 kilograms have been known to be necessary. As discussed at Section E3.3, above, each pond should be analysed after the first two storm events to determine the actual settling agent application rate and the settling time required.

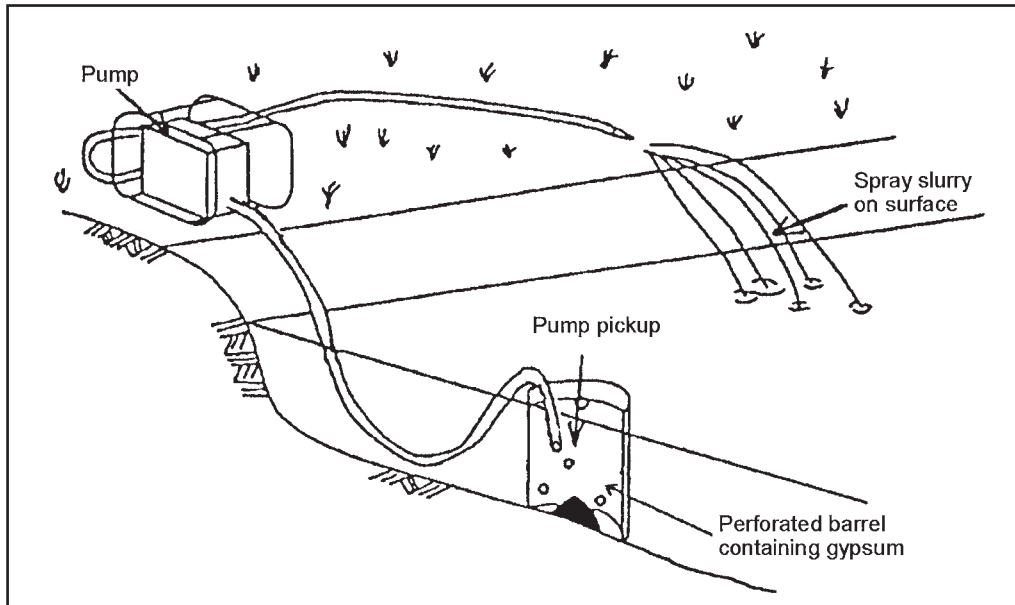

Figure E1. Application of gypsum



Figure E2. Poor gypsum application technique.

Spreading the gypsum evenly over the pond surface is essential. Figure E2 shows gypsum application where the slurry jet enters the water at too large an angle. In this instance, rates of up to 100 kilograms per 100 cubic metres of pond water were required to achieve the necessary water quality. Had the slurry jet entered the water at a much lower angle (e.g. at 10 or 20 degrees from the water surface), lower gypsum dosing rates could have been acceptable.

Assuming the pond is designed to the 5-day,  $\gamma$ -percentile depth (Section 6.3.4(c)), adequate settling is required in about four days from the conclusion of each storm event. This will allow one day to pump it out. The critical issue is to ensure the basin is pumped out and ready to receive more sediment-laden water within five days from the conclusion of a storm event. The water can be discharged from the basin once the suspended solid concentration has been lowered to the acceptable level. Treated basins should be dewatered with a system that:

- (i) ideally permits drainage of the pond in less than 24 hours ; and<sup>5]</sup>
- (ii) has a floating inlet to prevent settled sediments being removed as well – it is essential that materials from the sediment layer are not entrained and discharged in the dewatering process.

Of course, if the pond is designed to the 2, 10 or 20-day,  $\gamma$ -percentile depth, shorter or longer settling times apply, respectively.

## E4.2. Automated Dosing of Stormwater Using Polyaluminium Chloride

The rainfall activated settling system outlined here is based on the use of polyaluminium chloride (PAC) and is adapted from TP90 Flocculation Guidelines prepared for Auckland Regional Council (Beca Carter Hollings & Ferner, 2003). Aluminium settling agents other than PAC, including alum (aluminium sulphate) might also be suitable for use in this system. Irrespective of which agent is used, the system should be designed following Section E3.3, above.

While not as simple in design and operation as the gypsum system described in Section E4.1, above, the PAC system avoids the need for regular pumping out of a sediment basin after rainfall. As such, it could be more suitable where sediment retention basins are designed for the 2-day,  $\gamma$ -percentile storm depth or for use at those times of the year when rainfall can occur more frequently than every five days.

### (a) General System Details

The general components of the PAC sediment settlement system include a rainfall catchment tray, header tank, displacement tank and settling agent reservoir tank

---

5. Longer dewatering times are acceptable, so long as the full capacity of the settling zone is evacuated within the time period assumed in the design of the basin (e.g. five days from the completion of the storm event).

## APPENDIX F - Vegetation Stabilisation

The stability of a landform surface is dependant of many factors and includes:

- Slope
- The required level of erosion protection
- The quality and characteristics of soil or growing media
- Soil fertility
- Climate of the regional area
- Access to the area
- Visual amenity and ecological outcome;
- Type of vegetation (eg primary establishment (exotic grass/crop followed by secondary native vegetation)
- Establishment time to reach a level of erosion protection
- Cost and Maintenance;

Stabilisation of batters can be undertaken in a variety of ways that include:

- Broadcast seeding
- Soil binders such as Bitumen emulsion
- Mulch and Topsoil mixes
- Hydroseeding
- Straw mulching
- Hydromulching
- Erosion control blankets
- Placed turf; and
- Turf reinforcement mats;

As a guide Figure F1 provides a decision matrix to aid in determining a suitable product with Table F1 providing a Decision Support Matrix that provides an overview of constraints and issues with each selected product.

Figure F1 and Table F1 are extracts from the document, Guideline for Batter Surface Stabilisation using Vegetation by NSW Roads and Maritime Service (2015) which is recommended as a background document for the haul road project.

Note that establishing stabilising vegetation on steep batters such as proposed for the haul road project require special consideration. Refer to Table F1 for slopes of 66% (1:1.5).



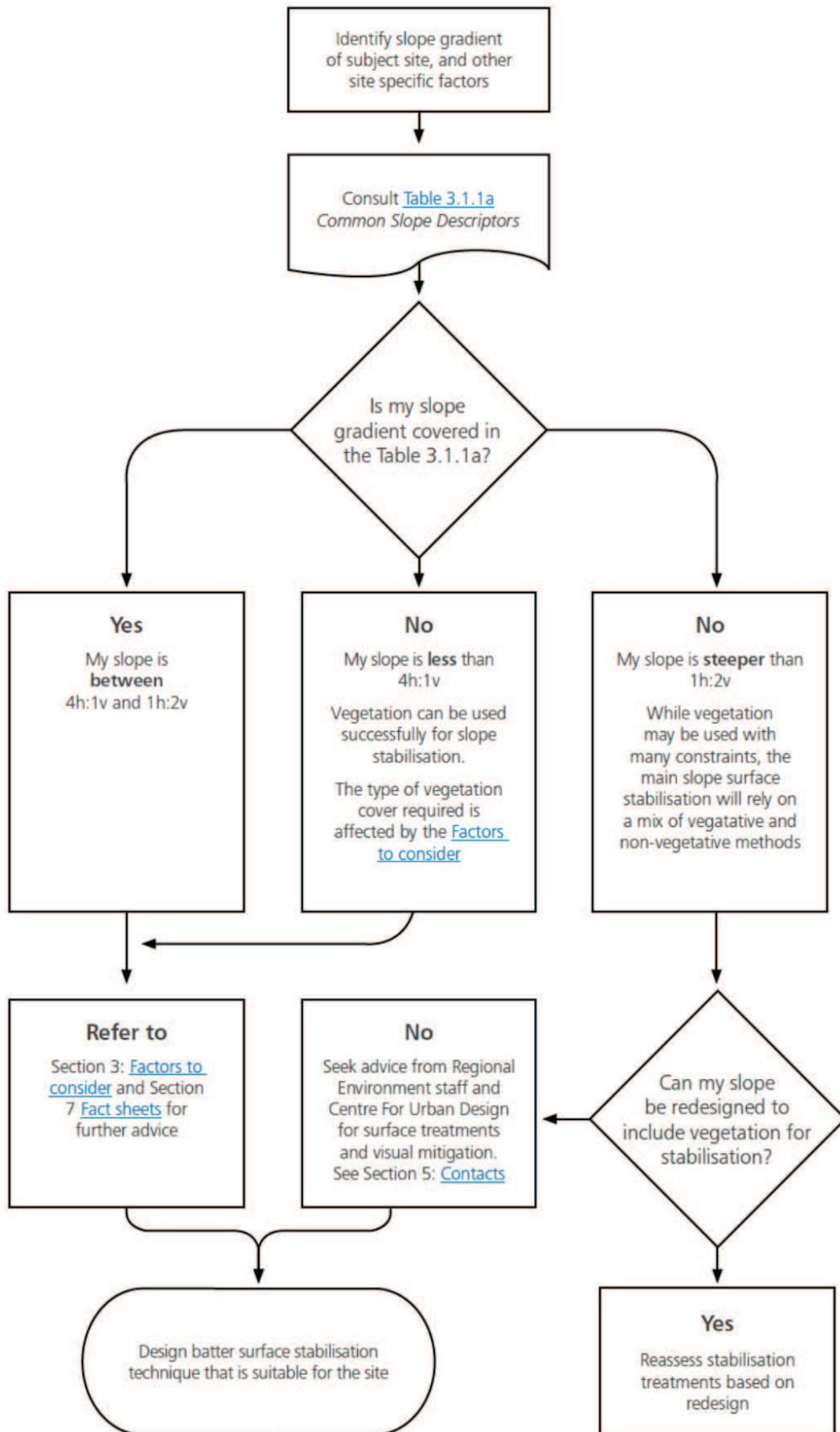









Figure F1: Vegetation Decision Flowchart









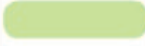

**Table F1: Decision Support Table for Choice of Stabilising Vegetation**

Batter stabilisation technique	Indicative cost	Time until erosion protection	Suitability for slope (described as horizontal run (h) to vertical rise (v) – see Table 3.1.1a)					
								
			4h:1v	3h:1v	2h:1v	1.5h:1v	1h:1v	1h:2v
<a href="#">Drill/Broadcast seeding</a>	\$	🕒	🟢	🟢	🟢	🟢	🟢	🟢
<a href="#">Soil binder – Bitumen emulsion</a>	\$	🕒	🟢	🟢	🟢	🟢	🟢	🟢
<a href="#">Soil binder – Tackifier</a>	\$	🕒	🟢	🟢	🟢	🟢	🟢	🟢
<a href="#">Mulch/Topsoil mixes</a>	\$	🕒	🟢	🟢	🟢	🟢	🟢	🟢
<a href="#">Hydroseeding</a>	\$	🕒	🟢	🟢	🟢	🟢	🟢	🟢
<a href="#">Straw mulching</a>	\$	🕒	🟢	🟢	🟢	🟢	🟢	🟢
<a href="#">Hydromulching – Standard</a>	\$	🕒	🟢	🟢	🟢	🟢	🟢	🟢
<a href="#">Hydromulching – Bonded fibre matrix</a>	\$	🕒	🟢	🟢	🟢	🟢	🟢	🟢
<a href="#">Hydromulching – Hydrocompost</a>	\$	🕒	🟢	🟢	🟢	🟢	🟢	🟢
<a href="#">Erosion control blanket – Organic fibre</a>	\$	🕒	🟢	🟢	🟢	🟢	🟢	🟢
<a href="#">Erosion control blanket – Synthetic</a>	\$	🕒	🟢	🟢	🟢	🟢	🟢	🟢
<a href="#">Cellular confinement systems</a>	\$	🕒	🟢	🟢	🟢	🟢	🟢	🟢
<a href="#">Compost blanket</a>	\$	🕒	🟢	🟢	🟢	🟢	🟢	🟢
<a href="#">Placed turf</a>	\$	🕒	🟢	🟢	🟢	🟢	🟢	🟢
<a href="#">2-D turf reinforcement mats</a>	\$	🕒	🟢	🟢	🟢	🟢	🟢	🟢
<a href="#">3-D turf reinforcement mats</a>	\$	🕒	🟢	🟢	🟢	🟢	🟢	🟢

## Key

Suitability for Slope	
	Technique is likely to work for slope
	Technique may work for the slope, if supplemented with other techniques
	Technique is not likely to work for the slope

Indicative Cost (at time of publication)	
	Low (~ \$0.15 – \$1.50/m <sup>2</sup> )
	Moderate (~ \$1.50 – \$5.00/m <sup>2</sup> )
	High (~ \$5.00 – \$10.00/m <sup>2</sup> )
	Very High (~ \$10.00 – \$35.00/m <sup>2</sup> )

Time until erosion protection	
	Slow (relies on establishment of vegetation)
	Rapid (within 48 hours, but erosion protection will be enhanced with vegetation establishment)
	Rapid (within 48 hours)
	Immediate (effective as soon as installation is complete)

## **APPENDIX G - Monitoring and Auditing Templates**

Supplied Templates to be amended to reflect stage of project

## Weekly Site Inspection

LOCATION .....

INSPECTION OFFICER ..... DATE .....

...

SIGNATURE .....

Legend:      √ OK                      X Not OK                      N/A Not applicable

Item	Consideration	Assessment
1	Public roadways clear of sediment.	.....
2	Entry/exit pads clear of excessive sediment deposition.	.....
3	Entry/exit pads have adequate void spacing to trap sediment.	.....
4	The construction site is clear of litter and unconfined rubbish.	.....
5	Adequate stockpiles of emergency ESC materials exist on site.	.....
6	Site dust is being adequately controlled.	.....
7	Appropriate drainage and sediment controls have been installed prior to new areas being cleared or disturbed.	.....
8	Up-slope “clean” water is being appropriately diverted around/through the site.	.....
9	Drainage lines are free of soil scour and sediment deposition.	.....
10	No areas of exposed soil are in need of erosion control.	.....
11	Earth batters are free of “rill” erosion.	.....
12	Erosion control mulch is not being displaced by wind or water.	.....
13	Long-term soil stockpiles are protected from wind, rain and stormwater flow with appropriate drainage and erosion controls.	.....
14	Sediment fences are free from damage.	.....
15	Sediment-laden stormwater is not simply flowing “around” the sediment fences or other sediment traps.	.....
16	Sediment controls placed up-slope/around stormwater inlets are appropriate for the type of inlet structure.	.....
17	All sediment traps are free of excessive sediment deposition.	.....

- 18 The settled sediment layer within a sediment basin is clearly visible through the supernatant prior to discharge such water. ....
- 19 All reasonable and practicable measures are being taken to control sediment runoff from the site. ....
- 20 All soil surfaces are being appropriately prepared (i.e. pH, nutrients, roughness and density) prior to revegetation. ....
- 21 Stabilised surfaces have a minimum 70% soil coverage. ....
- 22 The site is adequately prepared for imminent storms. ....
- 23 All ESC measures are in proper working order. ....

## Detailed Site Inspection Checklist

LOCATION OF DEVELOPMENT .....

.....

.....

INSPECTION OFFICER ..... DATE .....

...

SIGNATURE .....

N/A – not applicable

4 – acceptable controls adopted

7 – measures are not acceptable, or a potential problem exists

### Part A: Initial site inspection

Item	Consideration	Assessment
1	Has an Erosion and Sediment Control Plan (ESCP) been approved for the site?	.....
2	Have all necessary development approvals been obtained?	.....
3	Are site conditions consistent with those assumed within the approved ESCP?	.....
4	Are environmental values being adequately protected?	.....
5	Are all ESC-related development conditions being satisfied?	.....
6	Was the full perimeter of the work site inspected?	.....
7	Are all reasonable and practicable measures being taken to minimise environmental harm?	.....



## Part B: Site inspection and monitoring

Item	Consideration	Assessment
8	Appropriate in-house site inspections of ESC practices are being carried out such that all control measures are being maintained.	.....
9	Site inspections and monitoring are being carried out at appropriate times and intervals.	.....

## Part C: Site establishment

Item	Consideration	Assessment
10	Site access is controlled and the number of access points minimised.	.....
11	Adequate drainage and sediment controls exist at site entry/exit points.	.....
12	Adequate drainage, erosion and sediment controls have been placed around the site compound.	.....
13	Office compound area and car park gravelled/stabilised where necessary to control erosion and mud generation.	.....
14	Appropriate drainage and sediment controls are installed prior to new areas being cleared or disturbed.	.....

## Part D: Site and vegetation management

Item	Consideration	Assessment
15	Vegetation Management Plan (VMP) and/or landscape plan has been prepared.	.....
16	VMP and/or landscape plan is being appropriately implemented.	.....
17	Site personnel appear to be aware of ESC requirements and have ready access to the Erosion and Sediment Control Plan.	.....
18	ESC measures are being installed in accordance with the approved <i>Installation Sequence</i> .	.....

		.....
19	Adequate supplies of ESC materials stored on-site: such as straw bales, wire, stakes, sediment fence fabric, filter cloth, clean aggregate.	.....
20	Temporary access roads are stabilised where appropriate.	.....
21	Permanent roads are programmed to be sealed as soon as reasonable and practicable.	.....
22	Sediment deposition is <u>not</u> observed on external roads.	.....
23	Adequate records are being kept on chemical dosing of sediment basins, site inspections and site maintenance.	.....
24	The site is adequately prepared for the anticipated weather conditions.	.....
25	“Witness Points” and “Hold Points” are being appropriately managed and adhered to.	.....
26	Adequate protection provided for non-disturbance areas, buffer zones, protected trees.	.....
27	Disturbances removed from the drip line of protected trees.	.....
28	Brick-, masonry-, concrete-, and tile-cutting activities not carried out within road reserves (if possible) and all liquid waste is fully contained on-site or behind bunds.	.....

## Part E: Material and waste management

Item	Consideration	Assessment
29	Chemicals and petroleum products appropriately stored on site.	.....
30	Emergency spill response plan has been prepared for the site.	.....
31	Oil/petroleum spill containment/response kits available on-site where appropriate.	.....
32	Adequate litter and waste receptors exist on-site.	.....

- 33 Waste receptors for concrete, paints, acid washing, litter and building waste are being maintained. ....
- 34 Cement-laden liquid waste and wash-off is prevented from entering waterways and stormwater systems. ....
- 35 Waste water from construction activities such as wash water, de-watering operations, and dust control is being captured and treated. ....
- 36 On-site mortar/cement/concrete mixing is carried out behind earth bunds, or other such measures employed to fully contain cement-laden waste and spills. ....
- 37 Appropriate wash-down facilities provided from concrete trucks, mixing and pumping equipment. ....

## Part F: Soil management

Item	Consideration	Assessment
38	Topsoil stripped and stockpiled prior to major earthworks.	.....
39	Stockpiles located at least 5m away from top of watercourse banks.	.....
40	Long-term soil stockpiles adequately protected against wind and rain.	.....
41	Adequate sediment controls placed down-slope of stockpiles.	.....
42	Stockpile sediment control ( <i>Filter Fence</i> or <i>Sediment Fence</i> ) is appropriate for the soil type and site conditions.	.....
43	Adequate drainage controls placed up-slope of stockpiles.	.....
44	Soil stockpiles do not encroach upon protected vegetation.	.....
45	Subsoils adequately scarified prior to topsoil placement.	.....
46	Topsoil is being replaced at an adequate depth.	.....

## Part G: Drainage controls

Item	Consideration	Assessment
47	Construction Drainage Plans (CDPs) are consistent with actual site conditions (i.e. current stage of works).	.....
48	Drainage Control measures are consistent with the ESCP.	.....
49	Drainage Control measures are being adequately maintained in proper working order at all times.	.....
50	Adequate diversion/management of up-slope stormwater.	.....
51	Up-slope “clean” water is being appropriately diverted around/through the site in a non-erosive manner.	.....
52	Stormwater runoff diverted away from unstable slopes.	.....
53	Flow diversion channels/banks stabilised against erosion.	.....
54	Flow <u>not</u> unlawfully discharged onto an adjacent property.	.....
55	Spacing of cross drainage (e.g. <i>Catch Drains</i> or <i>Flow Diversion Banks</i> ) down long slopes is sufficient to prevent “rill” erosion.	.....
56	Earth batters are free of “rill” erosion.	.....
57	<b>Catch Drains:</b>	
	(a) Adequate depth/width.	.....
	(b) Adequate flow capacity is being maintained.	.....
	(c) Stabilised against soil scour.	.....
	(d) Clear of sediment deposition.	.....
	(e) Appropriate grass length is being maintained.	.....
	(f) Water discharges via a stable outlet.	.....
58	<b>Channel Linings (mats):</b>	
	(a) Lining is well anchored.	.....
	(b) Mats overlap in direction of flow.	.....
	(c) Lining is appropriate for flow conditions.	.....
	(d) No damage to the mat by lateral inflows.	.....
59	<b>Check Dams:</b>	
	(a) Flow is passing <u>over</u> the dams and not around them.	.....
	(b) Check Dams are <u>not</u> causing excessive channel restriction.	.....

- (c) Rock Check Dams are not used in shallow drains. ....
- (d) Check Dams are appropriately spaced down the drain. ....
- 60 **Chutes (rock):**
  - (a) Geotextile filter cloth is installed under the rock. ....
  - (b) Rock placement has not reduced chute flow capacity. ....
  - (c) Rock size appears adequate for expected flow velocity. ....
  - (d) Water discharges via a stable outlet. ....
- 61 **Chutes (geotextile):**
  - (a) Lining is well anchored. ....
  - (b) Mats overlap in direction of flow. ....
  - (c) Lining is appropriate for flow conditions. ....
  - (d) Water discharges through a stable outlet. ....
- 62 **Level Spreaders:**
  - (a) Outlet weir is level and undamaged. ....
  - (b) No sediment deposition within *Level Spreader*. ....
  - (c) Discharges “sheet” flow to a stable, well-grassed outlet. ....
- 63 **Slope Drains:**
  - (a) Adequate erosion/sediment controls at pipe inlet. ....
  - (b) Pipes are well anchored. ....
  - (c) No obvious water leaks. ....
  - (d) Water discharges via a stable outlet. ....
- 64 **Stormwater Outlets:**
  - (a) Energy dissipation is appropriate for the conditions. ....
  - (b) Rock size is greater than 200mm. ....
  - (c) Soil erosion is being controlled. ....
- 65 **Temporary Watercourse Crossings:**
  - (a) Crossing type is appropriate for the stream conditions. ....
  - (b) Sediment runoff from the approach roads is controlled. ....
  - (c) Likely damage to the crossing and the stream caused by possible overtopping flows is considered acceptable. ....

## Part H: Erosion controls

Item	Consideration	Assessment
66	Erosion control standard is consistent with requirements of regulatory authority.	.....
67	Soil erosion is being controlled to a standard consistent with the level of environmental risk.	.....
68	Erosion Control measures are consistent with the approved ESCP.	.....
69	Disturbance to existing ground cover is being delayed as long as possible.	.....
70	Raindrop impact erosion is being adequately controlled.	.....
71	Earth batters are free of “rill” erosion.	.....
72	Dust problems are being adequately controlled.	.....
73	Erosion Control measures are being adequately maintained in proper working order at all times.	.....
74	All disturbed areas are adequately stabilised given: (a) Erosion hazard risk. (b) Degree of downstream sediment control. (c) Days since earthworks were finalised. (d) Days before any soil disturbance will be re-worked.	..... ..... ..... .....
75	<b>Erosion Control Blankets:</b> (a) Blankets are well anchored. (b) Blankets overlap in direction of stormwater flow. (c) Blanket strength is appropriate for site conditions. (d) Synthetic blanket reinforcing will not endanger wildlife. (e) Blankets <u>not</u> damaged by lateral inflows. (f) Blankets protected against movement by winds.	..... ..... ..... ..... ..... .....
76	<b>Mulching (light):</b> (a) Minimum 70% coverage of soil surface. (b) Suitable tackifier used on steep slopes. (c) Drainage controls preventing mulch displacement.	..... ..... .....
77	<b>Mulch (heavy):</b> (a) Minimum 100% coverage of soil. (b) Minimum depth adequate to control weeds. (c) Drainage controls preventing mulch displacement.	..... ..... .....
78	<b>Soil Binders:</b>	



- (a) No adverse environmental impacts observed. ....
- (b) No obvious over-spray. ....
- (c) Soil binders applied during appropriate weather conditions. ....

## Part I: Sediment controls

Item	Consideration	Assessment
79	Sediment is being controlled to a standard consistent with legislative requirements and the level of environmental risk.	.....
80	Sediment Control is consistent with the approved ESCP.	.....
81	Sediment Control is appropriate for the soil type.	.....
82	No sub-catchment relies solely on “supplementary” sediment control traps.	.....
83	Sediment Control measures are being adequately maintained in proper working order at all times.	.....
84	Sediment control <i>Buffer Zones</i> are protected from traffic and are free of excessive sediment deposits.	.....
85	Straw bales are <u>not</u> being used for sediment control, unless justified by <u>exceptional</u> circumstances.	.....
86	Neighbouring properties are being adequately protected from sedimentation.	.....
87	Collected sediment is being disposed of in an appropriate manner.	.....
88	<b>Entry/Exit Points:</b>	
	(a) Control measures are appropriate for the site conditions.	.....
	(b) Control measures are constructed to appropriate standards.	.....
	(c) Excessive sediment removed from sediment traps.	.....
	(d) Excessive sedimentation is <u>not</u> evident on roadway.	.....
	(e) Stormwater drainage is controlled such that sediment is not being washed onto the adjacent roadway.	.....
89	<b>Field (Drop) Inlet Controls:</b>	
	(a) Inlet control measures allow adequate ponding around stormwater inlets to capture sediment.	.....
	(b) The sediment control measures do <u>not</u> simply divert sediment-laden water downstream to an uncontrolled	

- inlet. ....
- (c) Sediment control measures will not cause a safety or local flood hazard. ....
- (d) Sediment traps are appropriate for site conditions. ....
- (e) Excessive sediment deposition is removed from all traps. ....
- 90 **Gully Inlet Controls:**
  - (a) Sediment traps are appropriate for the type of gully inlet, either “sag” or “on-grade” inlet. ....
  - (b) Sediment traps allow adequate ponding around or up-slope of stormwater inlets to capture sediment. ....
  - (c) Sediment traps do not simply divert sediment-laden water downstream to an uncontrolled inlet. ....
  - (d) Sediment control measures will not cause a safety, traffic or local flooding hazard. ....
  - (e) Excessive sediment deposition is removed from all traps. ....
- 91 **Table drain sediment traps:**
  - (a) Choice of sediment trap is appropriate for flow conditions. ....
  - (b) Excessive sediment is removed from all traps. ....
  - (c) Spill-through weir is set to an appropriate elevation. ....
  - (d) Spill-through weir has adequate width. ....
  - (e) Sediment Fence traps are formed in a tight U-shape that adequately prevents water bypassing the traps. ....
- 92 **Sediment Fences:**
  - (a) Choice of fabric is appropriate. ....
  - (b) Bottom of fabric is securely buried. ....
  - (c) Fabric is appropriately overlapped at joints. ....
  - (d) Fabric is appropriately attached to posts. ....
  - (e) Support posts are at correct spacing (2m or 3m with backing). ....
  - (f) Sediment Fence does not cause flow diversion/bypass. ....
  - (g) Sediment Fence has regular returns. ....
  - (h) Lower end(s) of fence is/are returned up the slope. ....
  - (i) Sediment Fences are free of damage. ....
  - (j) All fences are free of excessive sediment deposition. ....
  - (k) Fences are adequately spaced from toe of fill banks. ....
- 93 **Filter Tube Sediment Traps:**
  - (a) Geometry and layout match design details. ....
  - (b) Sediment-laden water cannot bypass the filtration system. ....
  - (c) Filter Tubes do not need replacement. ....
  - (d) Filter Tubes and embankment are free of damage. ....
- 94 **Rock Filter Dams (Sediment Traps):**

- (a) Geometry and layout match design details. ....
- (b) Excessive sediment removed from up-slope of all traps. ....
- (c) The filtration system is free from sediment blockage. ....
- (d) Rock Filter Dam and spillway are free of damage. ....
- 95 **Sediment Weirs:**
- (a) Geometry and layout match design details. ....
- (b) Excessive sediment removed from up-slope of all traps. ....
- (c) The filtration system is free from sediment blockage. ....
- (d) Sediment Weir and splash pad (if any) are free of damage. ....
- 96 **Sediment Trench:**
- (a) Trench geometry and layout match design details. ....
- (b) Excessive sediment removed from the trench. ....
- (c) Outlet structure (if any) is free from sediment blockage. ....
- (d) The open trench does not represent a safety hazard. ....
- 97 **Sediment Controls for Non-Storm Runoff**
- (a) Choice of sediment trap is appropriate for the site conditions and level of environmental risk. ....
- (b) All sediment is being contained within trap. ....
- 98 **Sediment Basin (1): Location** . . . . .
- . . . . .
- (a) Basin geometry and layout match design details. ....
- (b) “As constructed” plans have been prepared. ....
- (c) The basin does not represent a safety risk. ....
- (d) De-watering is conducted in accordance with best practice. ....
- (e) Excessive sediment removed from basin. ....
- (f) Sediment depth marker is installed and maintained. ....
- (g) Primary outlet structure is free from sediment blockage. ....
- (h) Flow conditions are not compromised across the spillway. ....
- (i) Emergency spillway has adequate scour control. ....
- (j) Adequate quantities of flocculant (if required) exist on-site. ....
- (k) Soil erosion is adequately controlled at inlet points. ....
- (l) The settled sediment layer is clearly visible through ponded water prior to discharge such water. ....
- 99 **Sediment Basin (2): Location** . . . . .
- . . . . .
- (a) Basin geometry and layout match design details. ....
- (b) “As constructed” plans have been prepared. ....
- (c) The basin does not represent a safety risk. ....
- (d) De-watering is conducted in accordance with best practice. ....

- practice. ....
- (e) Excessive sediment removed from basin. ....
- (f) Sediment depth marker is installed and maintained. ....
- (g) Primary outlet structure is free from sediment blockage. ....
- (h) Flow conditions are not compromised across the spillway. ....
- (i) Emergency spillway has adequate scour control. ....
- (j) Adequate quantities of flocculant (if required) exist on-site. ....
- (k) Soil erosion is adequately controlled at inlet points. ....
- (l) The settled sediment layer is clearly visible through ponded water prior to discharge such water. ....

100

**Sediment Basin (3): Location** .....

- .....
- (a) Basin geometry and layout match design details. ....
- (b) “As constructed” plans have been prepared. ....
- (c) The basin does not represent a safety risk. ....
- (d) De-watering is conducted in accordance with best practice. ....
- (e) Excessive sediment removed from basin. ....
- (f) Sediment depth marker is installed and maintained. ....
- (g) Primary outlet structure is free from sediment blockage. ....
- (h) Flow conditions are not compromised across the spillway. ....
- (i) Emergency spillway has adequate scour control. ....
- (j) Adequate quantities of flocculant (if required) exist on-site. ....
- (k) Soil erosion is adequately controlled at inlet points. ....
- (l) The settled sediment layer is clearly visible through ponded water prior to discharge such water. ....

101

**Other Sediment Trap (1): Type** .....

- .....
- (a) Choice of sediment trap is appropriate for the site conditions and level of environmental risk. ....
- (b) The sediment trap allows adequate ponding to capture coarse sediment (Type 2 and Type 3 Sediment Traps). ....
- (c) The sediment trap allows adequate filtration to capture fine sediment (Type 2 Sediment Traps). ....
- (d) The sediment trap does not simply divert sediment-laden water downstream to an uncontrolled outlet. ....
- (e) The sediment trap does not cause a safety, traffic or local flood hazard. ....
- (f) Excessive sediment deposition is removed from all traps. ....

102

**Other Sediment Trap (2): Type** .....

- .....
- (a) Choice of sediment trap is appropriate for the site conditions and level of environmental risk. ....
- (b) The sediment trap allows adequate ponding to capture coarse sediment (Type 2 and Type 3 Sediment Traps). ....
- (c) The sediment trap allows adequate filtration to capture fine sediment (Type 2 Sediment Traps). ....
- (d) The sediment trap does not simply divert sediment-laden water downstream to an uncontrolled outlet. ....
- (e) The sediment trap does not cause a safety, traffic or local flood hazard. ....
- (f) Excessive sediment deposition is removed from all traps. ....
- 103 **Other Sediment Trap (3): Type** .....
- .....
- (a) Choice of sediment trap is appropriate for the site conditions and level of environmental risk. ....
- (b) The sediment trap allows adequate ponding to capture coarse sediment (Type 2 and Type 3 Sediment Traps). ....
- (c) The sediment trap allows adequate filtration to capture fine sediment (Type 2 Sediment Traps). ....
- (d) The sediment trap does not simply divert sediment-laden water downstream to an uncontrolled outlet. ....
- (e) The sediment trap does not cause a safety, traffic or local flood hazard. ....
- (f) Excessive sediment deposition is removed from all traps. ....
- 104 **Other Sediment Trap (4): Type** .....
- .....
- (a) Choice of sediment trap is appropriate for the site conditions and level of environmental risk. ....
- (b) The sediment trap allows adequate ponding to capture coarse sediment (Type 2 and Type 3 Sediment Traps). ....
- (c) The sediment trap allows adequate filtration to capture fine sediment (Type 2 Sediment Traps). ....
- (d) The sediment trap does not simply divert sediment-laden water downstream to an uncontrolled outlet. ....
- (e) The sediment trap does not cause a safety, traffic or local flood hazard. ....
- (f) Excessive sediment deposition is removed from all traps. ....

## Part J: Instream works

Item	Consideration	Assessment
105	All necessary State and local government approvals have been obtained.	.....
106	<i>Temporary Watercourse Crossings</i> (e.g. construction access) have been reduced to the minimum practical number.	.....
107	Instream disturbance is limited to the minimum necessary to complete the proposed works.	.....
108	Timing and staging of instream works will minimise exposure of the site to storm and/or stream flows.	.....
109	Instream works are occurring at a time of the year that will minimise overall potential environmental harm: (a) avoiding seasonal high flows; (b) avoiding periods of likely fish migration; (c) avoiding active bird migration periods (Ramsar wetlands).	..... ..... .....
110	Instream structures are not located on, or adjacent to, unstable or highly mobile channel bends.	.....
111	Construction works are not unnecessarily disturbing instream or riparian vegetation.	.....
112	Overbank disturbances are limited to only one bank wherever reasonable and practicable.	.....
113	Stormwater runoff moving towards the channel from adjacent areas is being appropriately diverted around soil disturbances.	.....
114	Erosion is not occurring as a result of stormwater passing down channel banks.	.....
115	Normal channel flows are being diverted around in-bank disturbances as appropriate for the expected weather and channel flow conditions.	.....
116	Appropriate temporary erosion control measures are being applied to disturbed areas.	.....
117	Synthetic reinforced erosion control blankets/mats are not being used where there is a potential threat to wildlife.	.....
118	Adopted instream sediment control measures are appropriate for the expected site and channel conditions.	.....



119	<i>Sediment Fences</i> have not been placed in areas of actual or potential concentrated flow.	.....
120	Appropriate material (spoil) de-watering procedures have been adopted.	.....
121	Site stabilisation and rehabilitation is occurring as soon as practicable.	.....
122	Appropriate site rehabilitation measures are being adopted.	.....

## Part K: Site stabilisation/revegetation

<b>Item</b>	<b>Consideration</b>	<b>Assessment</b>
123	Site stabilisation/rehabilitation plan has been prepared.	.....
124	Site stabilisation/revegetation is occurring in accordance with approved Plans and/or programming.	.....
125	Exposed areas are adequately stabilised given the site conditions, environmental risk, and construction schedule.	.....
126	Soil surfaces are suitably roughened prior to revegetation.	.....
127	Excessive soil compaction is amended prior to revegetation.	.....
128	Seedlings are appropriately stored prior to planting.	.....
129	Seedlings are <u>not</u> excessively mature for their pot/tube size.	.....
130	Drill seeding (if any) is being applied across the slope (not up and down the slope).	.....
131	Newly seeded areas are developing an appropriate grass cover (not just strike rate), density and grass type.	.....
132	No newly seeded areas require reseeding.	.....
133	Soil erosion within revegetated areas is being adequately controlled (i.e. mulching) during the plant establishment phase.	.....
134	Grass turfing is <u>not</u> being placed directly on compacted soil.	.....

- 135 Water application is appropriate for the site conditions and water conservation requirements. ....
- 136 Soils are being appropriately prepared (i.e. pH, nutrients, and so on) prior to revegetation. ....
- 137 Revegetation is controlling soil erosion as required. ....
- 138 Newly seeded areas have been lightly mulched as specified. ....
- 139 Adequate heavy mulching placed around seedlings. ....
- 140 Newly established plants are being adequately maintained. ....
- 141 Weeds and grasses are being controlled around the base of newly established trees and shrubs. ....
- 142 Plants damaged by traffic or wind-rock are adequately supported or replaced. ....
- 143 Dead or severely damaged plants have been replaced. ....

## Part L: Action summary

Item	Consideration	Yes or No
	<b>Answer “Yes” if further action is required on site</b>	
144	Do any existing control measures require modification?	.....
145	Are additional ESC measures required on the site?	.....
146	Are alternative ESC measures required on the site?	.....
147	Is a revised ESCP required for the site?	.....
148	Is further water quality monitoring required?	.....
149	Do any ESC measures need repairs or de-silting?	.....

- 150 Is additional erosion control (minimum 70% cover) required? .....
- 151 Will the underlying cause of any non-compliance need further investigation? .....
- 152 Will it be necessary for the site to adopt an alternative Code of Practice better suited to the site conditions or work activities? .....
- 153 Will further site inspections be required? .....

**Notes:**

.....

.....

.....

.....

.....

.....

.....

.....

.....

.....

.....

## NON-CONFORMANCE REPORT

Job Name:	Job No:
Date:	Client:
Details of non-conformance:	
Details of specification/procedure not conforming to:	
Non-conformance raised by:	Date:
Short-term preventative action:	
Estimated cost of rework/re-training/waste:	
Long-term preventative action:	
Accepted/rejected by the Client: Signed:	Date:
Non-conformance resolved: Signed:	Date:

**Event Based Monitoring Field Sheet**

Water Quality Discharge Objectives - Actions

Item	Groundwater Discharge Objectives	Contingency Action	Responsible Officer
<b>BASIN DISCHARGE POINT</b>	<p><b>Discharge Parameters</b></p> <p>See below table and attached template for monitoring frequencies and recording of data</p> <p>Site representative to carry out monitoring as required</p>	<p>For all other items tested, if they are outside of criteria</p> <p><b>Advise: ?</b></p> <p>Investigate to rectify</p>	<p><b>?</b></p> <p><b>and designated field staff</b></p>
	<p><b>pH of treated groundwater</b></p> <p>pH less than 6.5 or greater than 8.5</p>	<p><b>Advise ?</b></p> <p>investigate to rectify, isolate area of concern (source) to manage WQ of discharge</p>	<p><b>?</b></p> <p><b>and designated field staff</b></p>
	<p><b>Visible Oil &amp; Grease</b></p> <p>Oil grease visible on surface of discharge water</p>	<p>Discolouration</p> <p><b>Advise ?</b></p> <p>Investigate to rectify , isolate area of concern (source) to manage WQ of discharge</p>	<p><b>?</b></p> <p><b>and designated field staff</b></p>
	<p><b>Turbidity</b></p> <p>Visual sample or via meter</p>	<p>If turbid, very cloudy, etc</p> <p><b>Advise ?</b></p> <p>Investigate to rectify , isolate area of concern (source) to manage WQ of discharge</p>	<p><b>?</b></p> <p><b>and designated field staff</b></p>

THIS PAGE IS BLANK

THIS PAGE IS BLANK





Customer Service | 1300 292 872 | (02) 6670 2400

[tsc@tweed.nsw.gov.au](mailto:tsc@tweed.nsw.gov.au)  
[www.tweed.nsw.gov.au](http://www.tweed.nsw.gov.au)

Fax (02) 6670 2429  
PO Box 816  
Murwillumbah NSW 2484